

Miniature photoelectric switches series W4-3: The efficient space savers

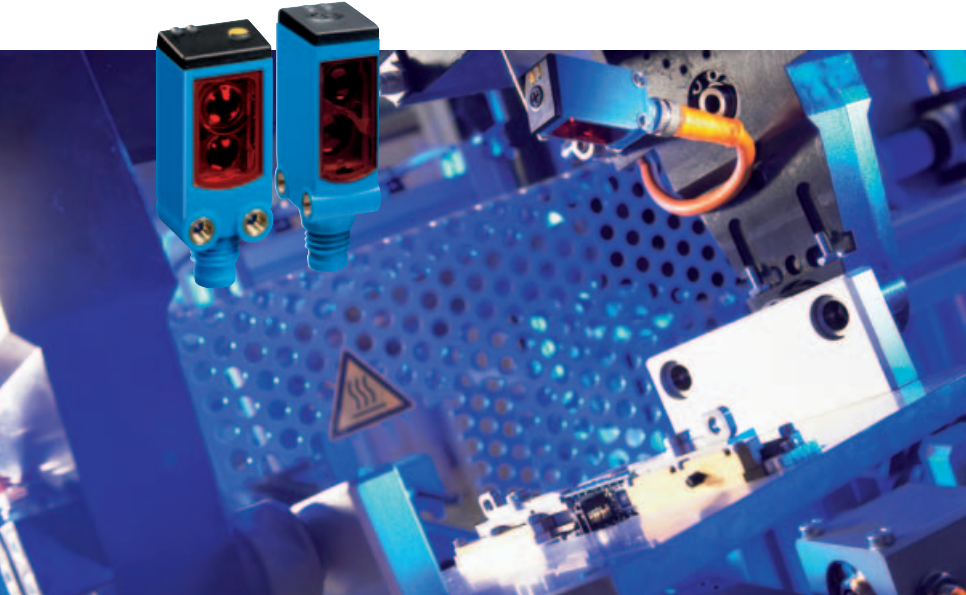

Photoelectric reflex switch with switching threshold adaptation and autocollimation.

Transparent objects of all kinds can be reliably detected in difficult and changing ambient conditions, with the switching threshold being automatically adapted to the changing ambient conditions, such as dust gathering on the optical surfaces.

Best background suppression in its class.

Background suppression offering more than just a good black/white displacement, i.e. object detection in front of reflective and moving backgrounds. The sensor has a 2nd sender LED allowing the sensor to see "spatially".

Optimum ambient light suppression.

The photoelectric proximity switch needs to detect objects directly in front of an energy-saving lamp or a fluorescent lamp – no problem. Light from such sources is identified and suppressed.

Hygienic and safe to use in aggressive environments.

Hydrofluoric acid, coolants, alcohols etc. cannot affect the fully Teflon-encapsulated versions – even when exposed for long periods.

It is the little things that make you "big": minimum size, maximum versatility. Three versions of the W4-3 series offer the users the following benefits for their application:

Clearly visible light spot.

The integration of new pinpoint LEDs creates brilliant, tightly defined light spots. Thus, the photoelectric switches can be aligned easily and quickly, as the light spot is easy to see even in bright ambient conditions.

	Photoelectric proximity switches BGS
	Photoelectric reflex switches
	Through-beam photoelectric switches

IO-Link

ECOLAB



SICK

W4-3 Selection table

Reliably solved with linear light spot featured in the WTB4-3:

- Continuous detection of honeycomb structured objects,
- Accurate positioning, irrespective of grooves or recesses in objects,
- Reliable detection of falling objects.

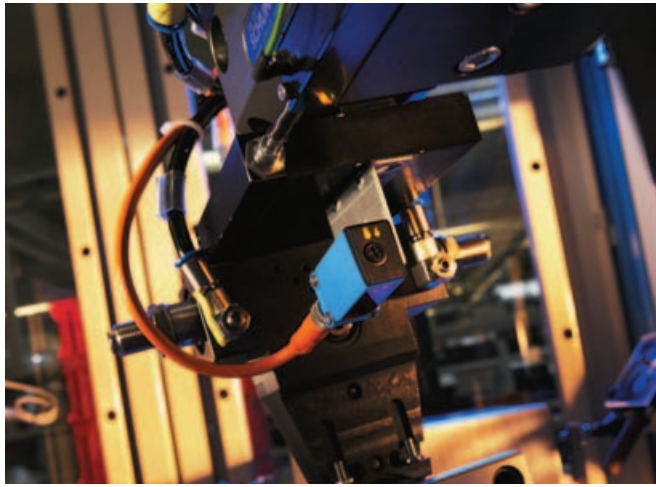
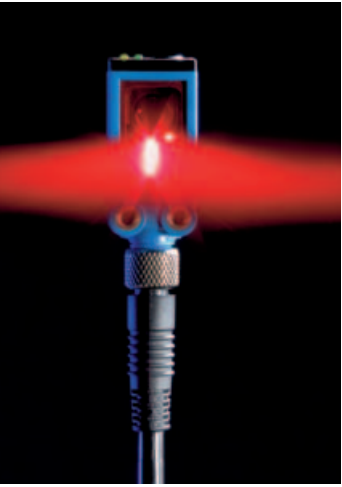

Photoelectric proximity switch WTB4S-3 with laser-like light spot: detection of the inserted PC board, at a distance of 80 mm, with pinpoint accuracy. The reflecting background does not interfere with the sensor's performance if no tool carrier is clamped and the robot moves.

Laser-like light spot in the WTB4S-3 for:

- Accurate positioning of the light beam on the object,
- Reliable detection of small objects immediately in front of a background,
- Very good visibility of the light spot on the object.

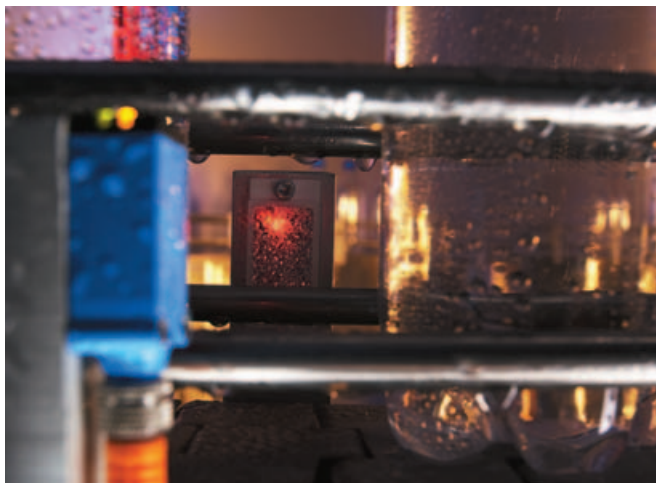

Safe and easy mounting. The mounting holes are fitted with M3 threaded metal bushes for added strength.

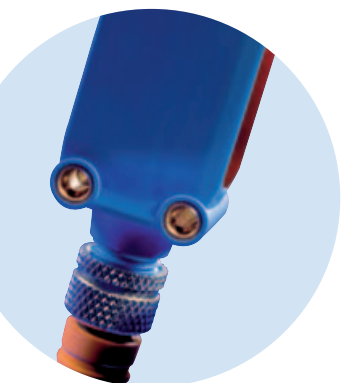

Photoelectric reflex switch WLG4S-3 thinks and controls with: automatic switching threshold adaptation – transparent objects with an attenuation of > 8% are reliably detected.

- Detection of transparent objects such as PET bottles, even with dust and moisture present,
- Implementation of the sensor close to the process, without expensive mounting systems,
- Clear visibility of the light spot aids the alignment of the sensor, from nearly all conceivable positions.

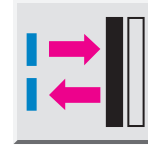

WTB4-3 – Photoelectric proximity switch with background suppression

Detection of objects, irrespective of colour and consistency, up to the predefined scanning distance

- Best background suppression
- Clearly visible light spot

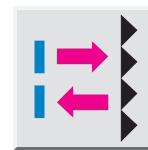

WL4-3 and WLG4-3 – Photoelectric reflex switches

Quick and easy alignment using the clearly visible light spot. Detection of transparent objects with switching threshold adaptation.

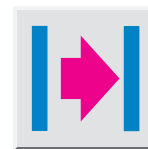

WSE4-3 – Through-beam photoelectric switches

Fast and reliable alignment of the sensors through brilliant light spot.



Housing

Version

Light beam geometry

Description

Side view
Slim housing



Standard photoelectric proximity switch
Scanning distance:
3 ... 150 mm



For standard applications: packaging, paper, cardboard, PC boards, solar cells.

Page
4 to 5

Laser-like
Scanning distance:
3 ... 120 mm

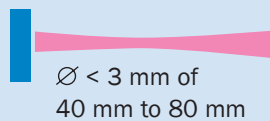

Detection and positioning of small parts and any object directly in front of a background.

6 to 11



Standard photoelectric proximity switch
Scanning distance:
3 ... 150 mm

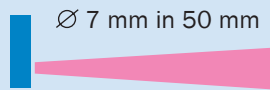

For standard applications: detection of packaging, paper, cardboard, PC boards, solar cells etc.

12 to 17



V-optics
Scanning distance:
3 ... 50 mm

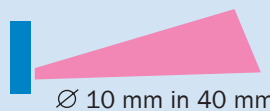

Detection of transparent and reflective objects: e.g. transparent trays, shiny packages, blister packs.

18 to 19



Line sensor
Scanning distance:
3 ... 150 mm



Detection of structured objects: grid boxes, PC boards with gaps, monitoring of small ejected parts.

20 to 21



Standard sensor in Teflon housing
Scanning distance:
4 ... 120 mm

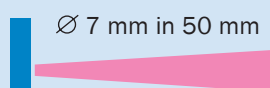

Detection of objects in harsh ambient conditions or directly in contact with liquids. H₂O₂-compatible.

22 to 23

Side view
Slim housing



Autocollimation with polarisation filter
Range: 0.0 ... 5 m



Small, high visibility light spot for the detection of small objects and where mounting space is restricted.

24 to 27

Photoelectric switch for glass detection with switching threshold adaptation
Range: 0.0 ... 5 m



Detection of transparent objects. Compensation for environmental effects such as temperature fluctuations, dust and dirt.

28 to 29



Standard with polarisation filter
Range: 0.01 ... 4 m

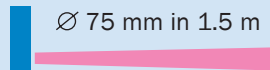

For standard applications: With and without Teach-in function, 2 sec. Teach for 50% switching threshold. 8 sec. long Teach for transparent objects with > 8% attenuation.

30 to 33

Photoelectric switch for glass detection
Range: 0.01 ... 1 m



Detection of PET bottles and foils > 8% attenuation and of objects with critical shiny surfaces such as foil packaging and coffee packages.

34 to 35

Side view
Slim housing



Range: 0 ... 5 m

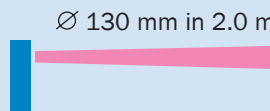

Detection of small parts, advantageous for applications where space is restricted and where reflective surfaces are present.

36 to 37



Range: 0 ... 6 m

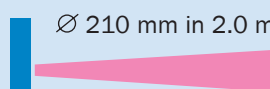

For standard applications: sender with test input.

38 to 39



Teflon housing
Range: 0 ... 3 m

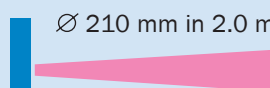

Detection of objects in harsh ambient conditions or directly in contact with liquids. H₂O₂-compatible.

40 to 41

Scanning distance
 4 ... 180 mm
 Photoelectric proximity switch

- Highly accurate adjustment of the scanning distance with 5-turn potentiometer
- Outstandingly visible and tightly defined light spot
- Robust mounting thanks to M3 metal bushes

Dimensional drawing

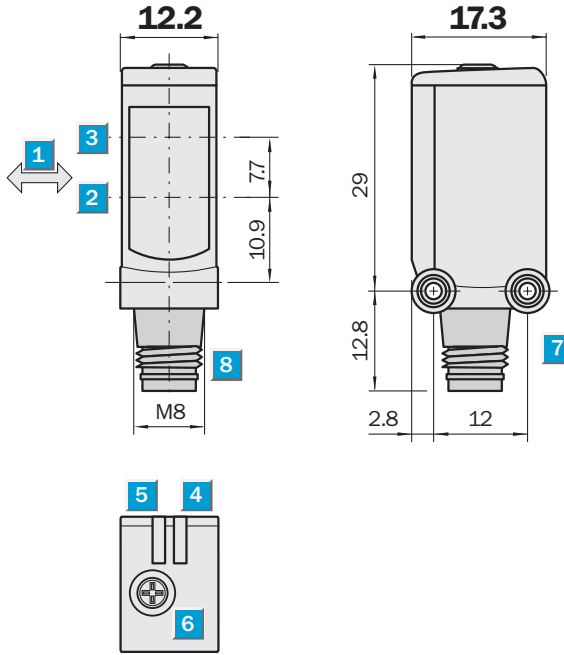

Adjustments possible



- 1 Standard direction of the material being scanned
- 2 Optical axis, receiver
- 3 Optical axis, sender
- 4 LED indicator green, power on
- 5 LED indicator yellow, status of received light beam
- 6 Potentiometer
- 7 Mounting hole M3
- 8 Connector



Connection type

WTB4S-3F2161	WTB4S-3P2261	WTB4S-3P3161	WTB4S-3E1361
WTB4S-3N2161			WTB4S-3N1361
WTB4S-3P2161			WTB4S-3P1361

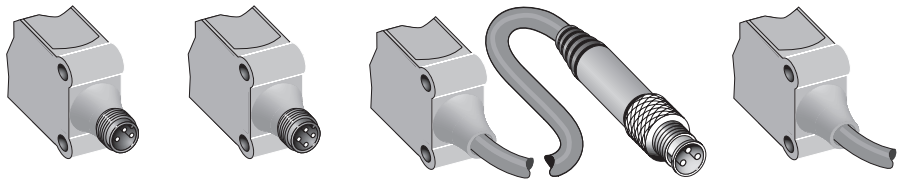

M8, 3-pin

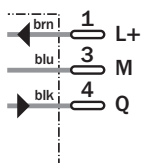

M8, 4-pin

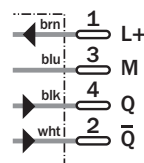

M8, 3-pin

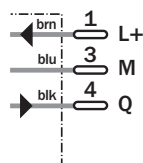

3 x 0.14 mm²

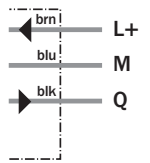

See Accessories chapter

- Connector, M8, 3-pin
- Connector, M8, 4-pin
- Mounting systems

WTB4S-3		E1361	F2161	N1361	N2161	P1361	P2161	P2261	P3161		
Scanning distance typ. max.	4 ... 180 mm										
Operating distance	10 ... 180 mm										
Adjustment of operating distance	Potentiometer, 5 revolutions										
Light source, light type	Pinpoint LED, red light, 650 nm ¹⁾										
Light spot diameter	6.5 mm at 150 mm distance										
Supply voltage V_s	DC 10 ... 30 V ²⁾										
Ripple	< 5 V _{ss} ³⁾										
Power consumption	≤ 30 mA ⁴⁾										
Switching outputs	NPN, Q										
	PNP, Q										
	PNP antivalent										
Switching mode	Dark-switching										
	Light-switching										
	Complementary										
Output current I _a max	≤ 100 mA										
Response time	< 0.5 s ⁵⁾										
Switching frequency	1,000 Hz ⁶⁾										
Connection type	Cable, PVC, 2 m ⁷⁾										
	Connector, M8, 3-pin										
	Connector, M8, 4-pin										
	Cable with plug, M8, 3-pin, PVC, 100 mm ⁷⁾										
VDE protection class	◆										
Circuit protection	V _s connections reverse-polarity protected / Output Q and Q not short-circuit protected / Interference suppression										
Enclosure rating	IP 66, IP 67										
Ambient temperature operation	-40 °C ... +60 °C										
Ambient temperature storage	-40 °C ... +75 °C										
Weight	Ca. 20 g										
Housing material	Novodur, PMMA										

¹⁾ Average service life 100,000 h at Ta = +25 °C
²⁾ Limit values

³⁾ May not exceed or fall short of V_s tolerances
⁴⁾ Without load

⁵⁾ Signal transit time with resistive load
⁶⁾ With light/dark ratio 1:1
⁷⁾ Do not bend below 0 °C

Scanning distance

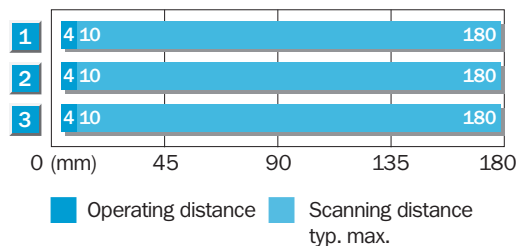

- 1 Scanning distance on black, 6 % remission
- 2 Scanning distance on grey, 18 % remission
- 3 Scanning distance on white, 90 % remission

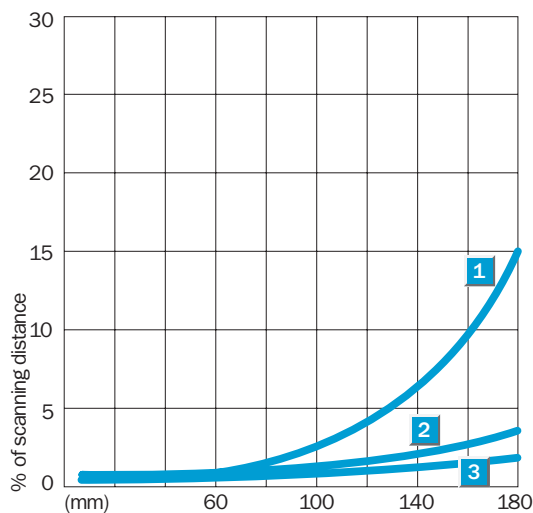

Ordering information	
Type	Order no.
WTB4S-3E1361	1042047
WTB4S-3F2161	1042044
WTB4S-3N1361	1042046
WTB4S-3N2161	1042045
WTB4S-3P1361	1042043
WTB4S-3P2161	1042040
WTB4S-3P2261	1042041
WTB4S-3P3161	1042042

Scanning distance
4 ... 120 mm

Photoelectric proximity switch

- Highly accurate adjustment of the scanning distance with 5-turn potentiometer
- Easily visible laser-type light spot
- Robust mounting thanks to M3 metal bushes

Dimensional drawing

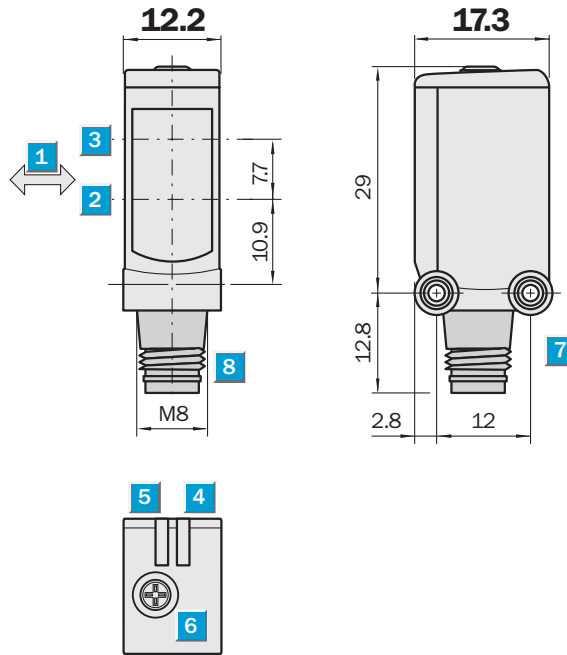

Adjustments possible



- 1 Standard direction of the material being scanned
- 2 Optical axis, receiver
- 3 Optical axis, sender
- 4 LED indicator green, power on
- 5 LED indicator yellow, status of received light beam
- 6 Potentiometer
- 7 Mounting hole M3
- 8 Connector

Connection type

WTB4S-3E1331	WTB4S-3P2231	WTB4S-3P3131	WTB4S-3F2131
WTB4S-3N1331			WTB4S-3N2131
WTB4S-3P1331			WTB4S-3P2131

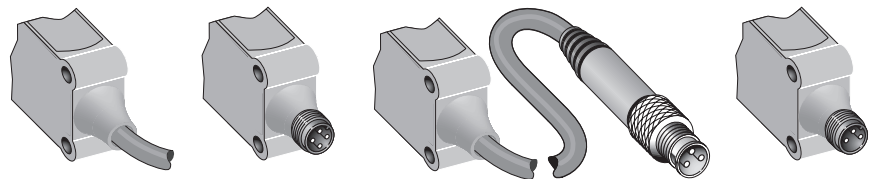

3 x 0.14 mm²

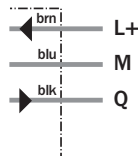

M8, 4-pin

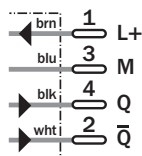

M8, 3-pin

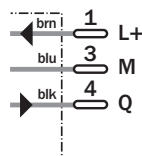

M8, 3-pin

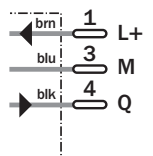

WTB4S-3N1131
4 x 0.14 mm²

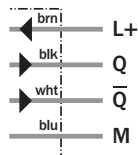

See Accessories chapter

Connector, M8, 3-pin

Connector, M8, 4-pin

Mounting systems

WTB4S-3		E1331	F2131	N1131	N1331	N2131	P1331	P2131	P2231	P3131
Scanning distance typ. max.	4 ... 120 mm									
Operating distance	10 ... 120 mm									
Adjustment of operating distance	Potentiometer, 5 revolutions									
Light source, light type	Pinpoint LED, red light, 650 nm ¹⁾									
Light spot diameter	2.5 mm at 50 mm distance									
Supply voltage V_s	DC 10 ... 30 V ²⁾									
Ripple	< 5 V _{ss} ³⁾									
Power consumption	≤ 30 mA ⁴⁾									
Switching outputs	NPN, Q									
	PNP, Q									
	NPN antivalent									
	PNP antivalent									
Switching mode	Dark-switching									
	Complementary									
	Light-switching									
Output current I _a max	≤ 100 mA									
Response time	< 0.5 s ⁵⁾									
Switching frequency	1,000 Hz ⁶⁾									
Connection type	Cable, PVC, 2 m ⁷⁾									
	Connector, M8, 3-pin									
	Connector, M8, 4-pin									
	Cable with plug, M8, 3-pin, PVC, 100 mm ⁷⁾									
VDE protection class	⊕									
Circuit protection	V _s connections reverse-polarity protected / Output Q and Q not short-circuit protected / Interference suppression									
Enclosure rating	IP 66, IP 67									
Ambient temperature operation	-40 °C ... +60 °C									
Ambient temperature storage	-40 °C ... +75 °C									
Weight	Ca. 20 g									
Housing material	Novodur, PMMA									

¹⁾ Average service life 100,000 h at Ta = +25 °C
²⁾ Limit values

³⁾ May not exceed or fall short of V_s tolerances
⁴⁾ Without load

⁵⁾ Signal transit time with resistive load
⁶⁾ With light/dark ratio 1:1
⁷⁾ Do not bend below 0 °C

Scanning distance

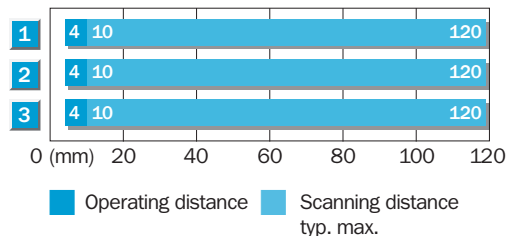

- 1 Scanning distance on black, 6% remission
- 2 Scanning distance on grey, 18% remission
- 3 Scanning distance on white, 90% remission

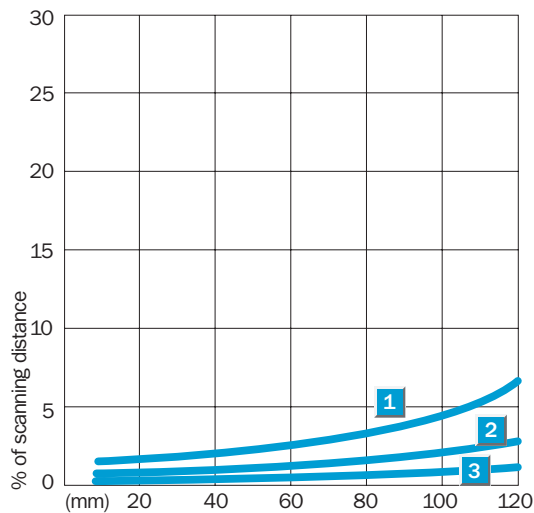

Ordering information

Type	Order no.
WTB4S-3E1331	1042064
WTB4S-3F2131	1042060
WTB4S-3N1131	1042063
WTB4S-3N1331	1042062
WTB4S-3N2131	1042061
WTB4S-3P1331	1042059
WTB4S-3P2131	1042056
WTB4S-3P2231	1042057
WTB4S-3P3131	1042058



Scanning distance
 4 ... 120 mm
Photoelectric proximity switch

- Easy commissioning through teach-in function
- Easily visible laser-type light spot
- Robust mounting thanks to M3 metal bushes

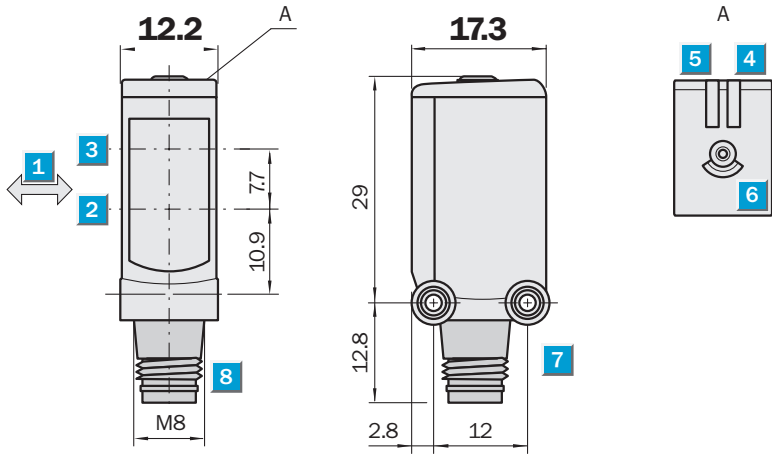
Dimensional drawing

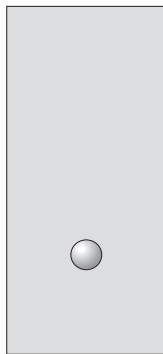

Adjustments possible



- 1** Standard direction of the material being scanned
- 2** Optical axis, receiver
- 3** Optical axis, sender
- 4** LED indicator green, power on
- 5** LED indicator yellow, status of received light beam
- 6** Teach-in button
- 7** Mounting hole M3
- 8** Connector



Connection type

WTB4S-3N1332	WTB4S-3N1134	WTB4S-3P2132	WTB4S-3P2234
--------------	--------------	--------------	--------------

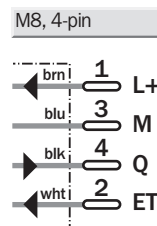
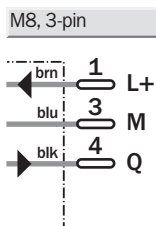
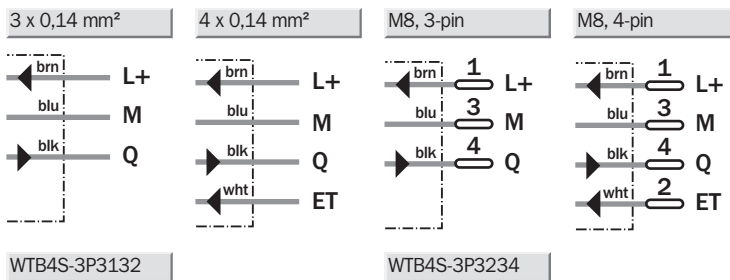
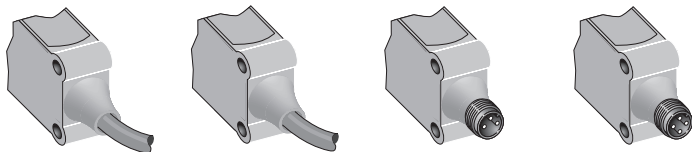

See Accessories chapter

Connector, M8, 3-pin

Connector, M8, 4-pin

Mounting systems

WTB4S-3		N1134	N1332	P2132	P2234	P3132	P3234				
Scanning distance typ. max.	4 ... 120 mm										
Operating distance	10 ... 120 mm										
Adjustment of operating distance	Teach-in: single-teach button & cable ¹⁾										
	Teach-in: single-teach button										
Light source, light type	Pinpoint LED, red light, 650 nm ²⁾										
Light spot diameter	2.5 mm at 50 mm distance										
Supply voltage V_s	DC 10 ... 30 V ³⁾										
Ripple	< 5 V _{ss} ⁴⁾										
Power consumption	≤ 30 mA ⁵⁾										
Switching outputs	NPN, Q										
	PNP, Q										
Switching mode	Light-switching										
Output current I _a max	≤ 100 mA										
Response time	< 0.5 ms ⁶⁾										
Switching frequency	1,000 Hz ⁷⁾										
Connection type	Cable, PVC, 2 m ⁸⁾										
	Connector, M8, 3-pin										
	Connector, M8, 4-pin										
	Cable with plug, M8, 3-pin, PVC, 100 mm ⁸⁾										
	Cable with plug, M8, 4-pin, PVC, 100 mm ⁸⁾										
VDE protection class	◊										
Circuit protection	V _s connections reverse-polarity protected / Output Q and Q not short-circuit protected / Interference suppression										
Enclosure rating	IP 66, IP 67										
Ambient temperature operation	-40 °C ... +60 °C										
Ambient temperature storage	-40 °C ... +75 °C										
Weight	Ca. 20 g										
Housing material	Bayblend, PMMA										

¹⁾ External teach-in: impulses > 2 s with voltage V_s for PNP or M for NPN

²⁾ Average service life 100,000 h at

T_a=+25 °C

³⁾ Limit values

⁴⁾ May not exceed or fall short of

V_s tolerances

⁵⁾ Without load

⁶⁾ Signal transit time with resistive load

⁷⁾ With light/dark ratio 1:1

⁸⁾ Do not bend below 0 °C

Scanning distance

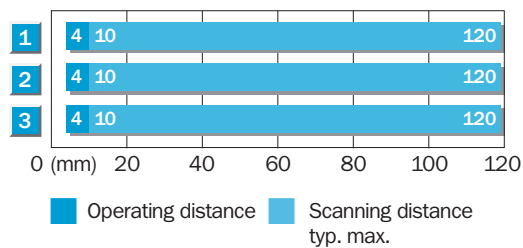

- 1 Scanning distance on black, 6 % remission
- 2 Scanning distance on grey, 18 % remission
- 3 Scanning distance on white, 90 % remission

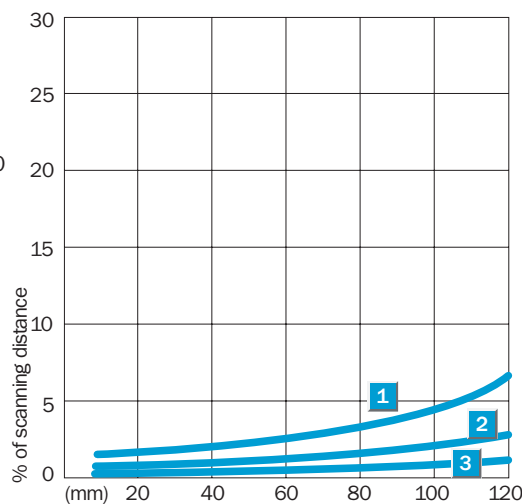

Order information

Type	Order no.
WTB4S-3N1134	1042052
WTB4S-3N1332	1042055
WTB4S-3P2132	1042053
WTB4S-3P2234	1042050
WTB4S-3P3132	1042054
WTB4S-3P3234	1042051

Scanning distance
4 ... 120 mm

Photoelectric proximity switch

- Parameterisation and diagnostics via IO-Link
- Easily visible laser-type light spot
- Robust mounting thanks to M3 metal bushes

Dimensional drawing

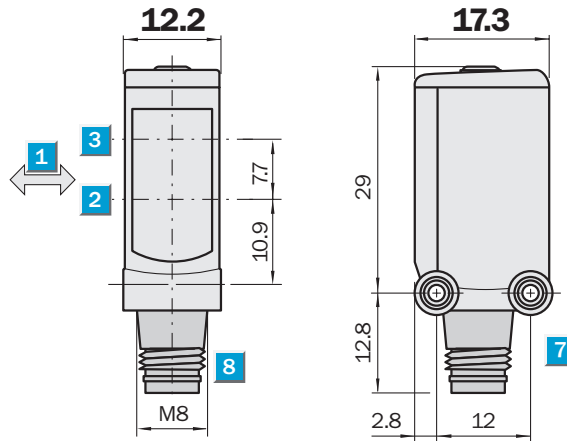

Adjustments possible

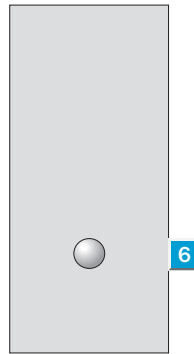

- 1 Standard direction of the material being scanned
- 2 Optical axis, receiver
- 3 Optical axis, sender
- 4 LED indicator green, power on
- 5 LED indicator yellow, status of received light beam
- 6 Teach button
- 7 Mounting hole M3
- 8 Connector

Connection type

WTB4SC-3P2232 WTB4SC-3P3432

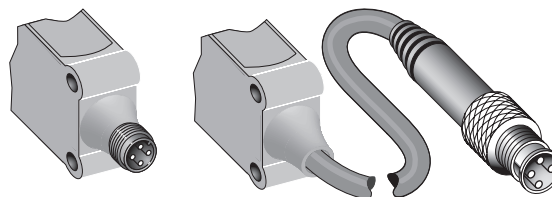

M8, 4-pin

M12, 4-pin

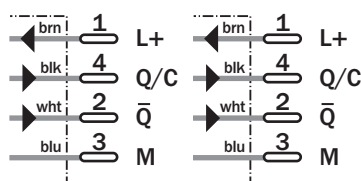

See Accessories chapter

Connector, M12, 4-pin

Connector, M8, 4-pin

Mounting systems

WTB4SC-3		P2232	P3432											
Scanning distance typ. max.	4 ... 120 mm													
Operating distance	10 ... 120 mm													
Adjustment of operating distance	Teach-in: single-teach button Teach-in: via IO-Link													
Communication mode	COM2													
Light source, light type	Pinpoint LED, red light, 660 nm ¹⁾													
Light spot diameter	2.5 mm at 50 mm distance													
Supply voltage V_s	DC 18 ... 30 V ²⁾													
Ripple	≤ 5 V _{ss} ³⁾													
Power consumption	≤ 30 mA ⁴⁾													
Switching outputs	PNP, Q/C PNP, not Q													
Switching mode	Light-switching ⁵⁾													
Output current I _a max	< 100 mA													
Response time	< 0.65 ms ⁶⁾													
Switching frequency	1,000 Hz ⁷⁾													
Connection type	Connector, M8, 4-pin													
	Cable with plug, M12, 4-pin, PVC, 150 mm ⁸⁾													
VDE protection class	⊕													
Circuit protection	V _s connections reverse-polarity protected / All outputs short-circuit protected / Interference suppression													
Enclosure rating	IP 66, IP 67													
Ambient temperature operation	-40 °C ... +60 °C													
Ambient temperature storage	-40 °C ... +75 °C													
Weight	Ca. 20 g													
Housing material	Bayblend, PMMA													

¹⁾ Average service life 100,000 h at Ta = +25 °C

²⁾ Limit values

³⁾ May not exceed or fall short of V_s tolerances

⁴⁾ Without load

⁵⁾ Parametrisable via IO-Link

⁶⁾ Signal transit time with resistive load in switching mode. Different values possible

in COM2 mode.

⁷⁾ With light/dark ratio 1:1 in switching mode. Different values possible in COM2 mode.

⁸⁾ Do not bend below 0 °C

Scanning distance

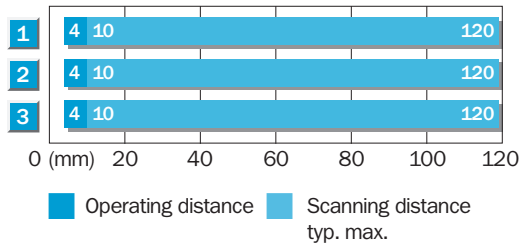

- 1 Scanning distance on black, 6 % remission
- 2 Scanning distance on grey, 18 % remission
- 3 Scanning distance on white, 90 % remission

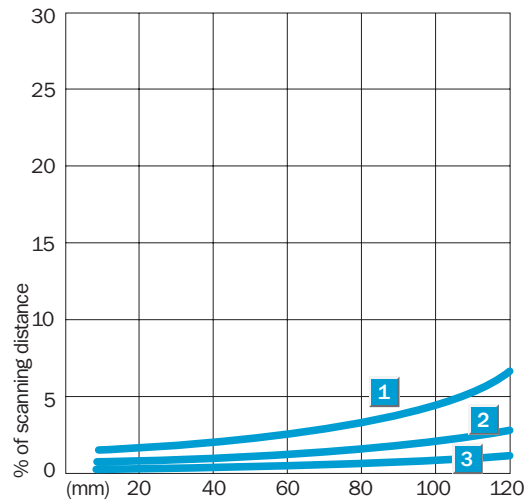

Ordering information

Type	Order no.
WTB4SC-3P2232	1042049
WTB4SC-3P3432	1042048

Scanning distance
 4 ... 150 mm
Photoelectric proximity switch

- High-precision setting of scanning distance thanks to 5-turn potentiometer
- Object detection almost irrespective of colour and background consistency
- Secure function when mounted opposite other sensors

Dimensional drawing

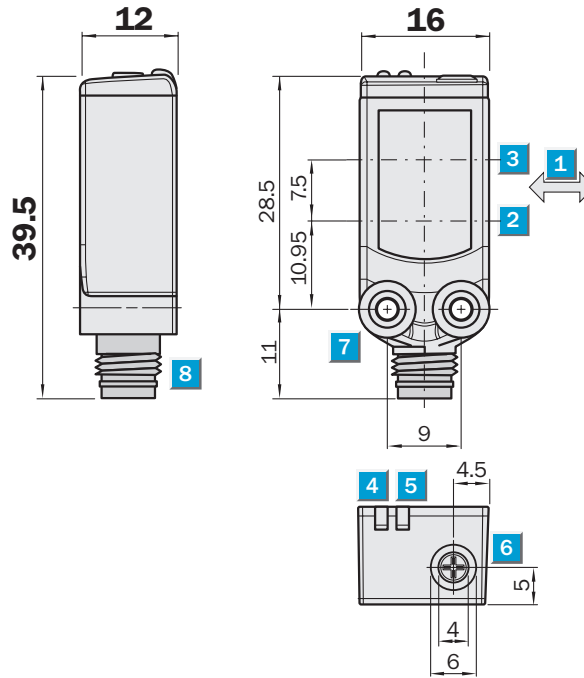

Adjustments possible

- 1 Standard direction of the material being scanned
- 2 Optical axis, receiver
- 3 Optical axis, sender
- 4 LED indicator yellow, status of received light beam
- 5 LED indicator green, power on
- 6 Potentiometer
- 7 Mounting hole M3
- 8 Connector



Connection type

WTB4-3P1361
WTB4-3N1361

WTB4-3F2161
WTB4-3N2161
WTB4-3P2161

WTB4-3F3161
WTB4-3P3161

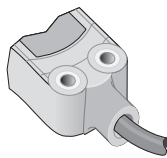

3 x 0.14 mm²

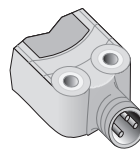
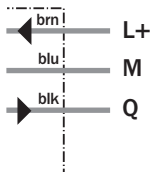

M8, 3-pin

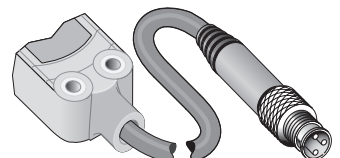
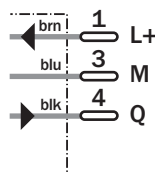

M8, 3-pin

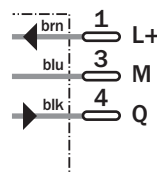

WTB4-3N1161
4 x 0.14 mm²

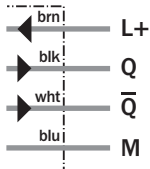

WTB4-3P2261
M8, 4-pin

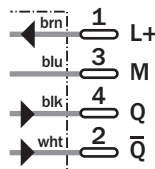

WTB4-3P3261
M8, 4-pin

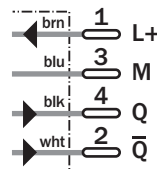

See Accessories chapter

- Connector, M8, 3-pin
- Connector, M8, 4-pin
- Mounting systems

WTB4-3		F2161	F3161	N1161	N1361	N2161	P1361	P2161	P2261	P3161	P3261
Scanning distance typ. max.	4 ... 150 mm										
Operating distance	15 ... 150 mm										
Adjustment of operating distance	Potentiometer, 5 revolutions										
Light source, light type	Pinpoint LED, red light, 650 nm ¹⁾										
Light spot diameter	7 mm at 50 mm distance										
Supply voltage V_s	DC 10 ... 30 V ²⁾										
Ripple	< 5 V _{ss} ³⁾										
Power consumption	≤ 30 mA ⁴⁾										
Switching outputs	PNP, Q										
	NPN antivalent										
	NPN, Q										
	PNP antivalent										
Switching mode	Dark-switching										
	Complementary										
	Light-switching										
Output current I _a max	≤ 100 mA										
Response time	< 0.5 ms ⁵⁾										
Switching frequency	1,000 Hz ⁶⁾										
Connection type	Connector, M8, 3-pin										
	Cable with plug, M8, 3-pin, PVC, 100 mm ⁷⁾										
	Cable, PVC, 2 m ⁷⁾										
	Connector, M8, 4-pin										
	Cable with plug, M8, 4-pin, PVC, 100 mm ⁷⁾										
VDE protection class	⊠										
Circuit protection	V _s connections reverse-polarity protected / Output Q and Q not short-circuit protected / Interference suppression										
Enclosure rating	IP 66, IP 67										
Ambient temperature operation	-40 °C ... +60 °C										
Ambient temperature storage	-40 °C ... +75 °C										
Weight	Ca. 20 g										
Housing material	Bayblend, PMMA										

¹⁾ Average service life 100,000 h at Ta = +25 °C
²⁾ Limit values

³⁾ May not exceed or fall short of V_s tolerances
⁴⁾ Without load

⁵⁾ Signal transit time with resistive load
⁶⁾ With light/dark ratio 1:1
⁷⁾ Do not bend below 0 °C

Scanning distance

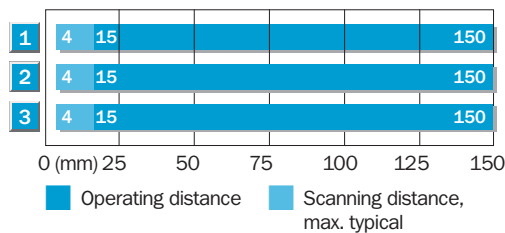

- 1 Scanning range on black, 6 % remission
- 2 Scanning range on grey, 18 % remission
- 3 Scanning range on white, 90 % remission

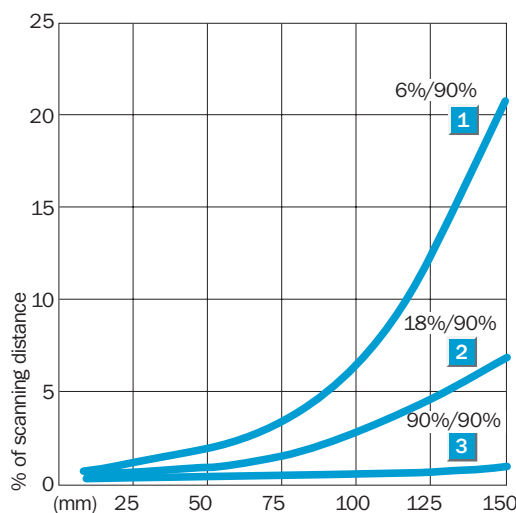

Ordering information

Type	Order no.
WTB4-3F2161	1028107
WTB4-3F3161	1028106
WTB4-3N1161	1028102
WTB4-3N1361	1028101
WTB4-3N2161	1028104
WTB4-3P1361	1028094
WTB4-3P2161	1028099
WTB4-3P2261	1028100
WTB4-3P3161	1028097
WTB4-3P3261	1028098

Additional types on request

Scanning distance
4 ... 150 mm

Photoelectric proximity switch

- Commissioning by simple teach-in function
- Object detection almost irrespective of colour and background consistency
- Secure function when mounted opposite other sensors

Dimensional drawing

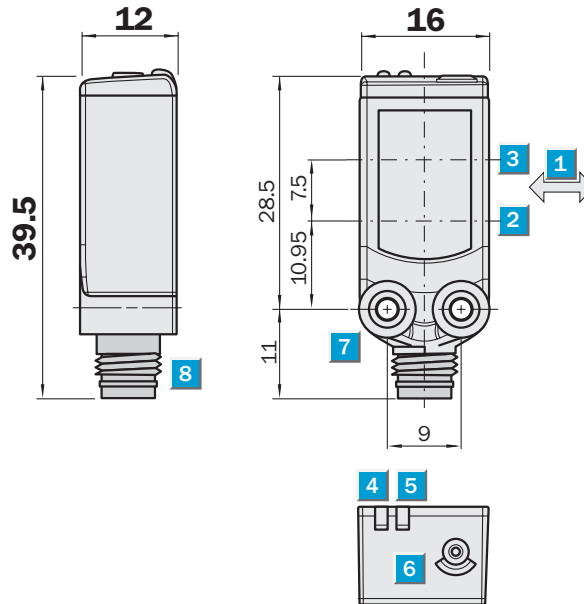

Adjustments possible

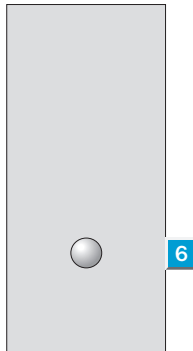

- 1 Standard direction of the material being scanned
- 2 Optical axis, receiver
- 3 Optical axis, sender
- 4 LED indicator yellow, status of received light beam
- 5 LED indicator green, power on
- 6 Teach button
- 7 Mounting hole M3
- 8 Connector

Connection type

WTB4-3N1164	WTB4-3P2262	WTB4-3N2162	WTB4-3N3162
WTB4-3P1164		WTB4-3P2162	WTB4-3P3162

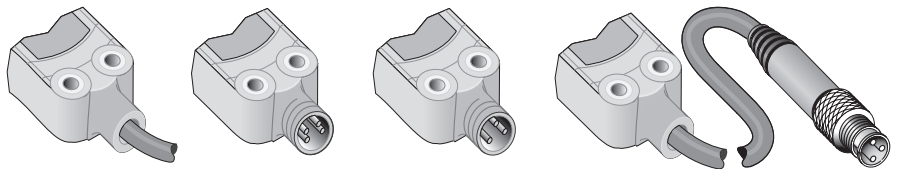

4 x 0.14 mm ²	M8, 4-pin	M8, 3-pin	M8, 3-pin
--------------------------	-----------	-----------	-----------

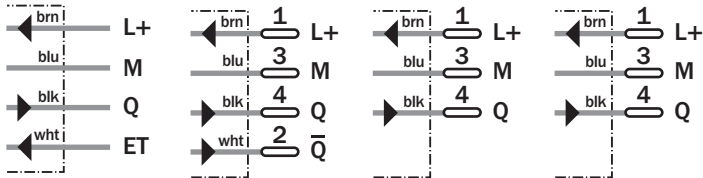

WTB4-3N1362	WTB4-3P2264
WTB4-3P1362	M8, 4-pin
3 x 0.14 mm ²	

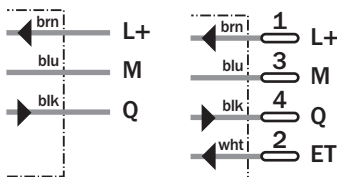

See Accessories chapter

Connector, M8, 3-pin
Connector, M8, 4-pin
Mounting systems

WTB4-3		N1164	N1362	N2162	N3162	P1164	P1362	P2162	P2262	P2264	P3162
Scanning distance typ. max.	4 ... 150 mm										
Operating distance	15 ... 150 mm										
Adjustment of operating distance	Teach-in: single-teach button & cable ¹⁾										
	Teach-in: single-teach button										
Light source, light type	Pinpoint LED, red light, 650 nm ²⁾										
Light spot diameter	7 mm at 50 mm distance										
Supply voltage V_s	DC 10 ... 30 V ³⁾										
Ripple	< 5 V _{ss} ⁴⁾										
Power consumption	≤ 30 mA ⁵⁾										
Switching outputs	NPN, Q										
	PNP, Q										
	PNP antivalent										
Switching mode	Light-switching										
	Complementary										
Output current I _a max	≤ 100 mA										
Response time	< 0.5 ms ⁶⁾										
Switching frequency	1,000 Hz ⁷⁾										
Connection type	Cable, PVC, 2 m ⁸⁾										
	Connector, M8, 3-pin										
	Cable with plug, M8, 3-pin, PVC, 100 mm ⁸⁾										
	Connector, M8, 4-pin										
VDE protection class	⊠										
Circuit protection	V _s connections reverse-polarity protected / Output Q and Q not short-circuit protected / Interference suppression										
Enclosure rating	IP 66, IP 67										
Ambient temperature operation	-40 °C ... +60 °C										
Ambient temperature storage	-40 °C ... +75 °C										
Weight	Ca. 20 g										
Housing material	Bayblend, PMMA										

¹⁾ External teach-in: impulses > 2 s with voltage V_s for PNP or M for NPN

²⁾ Average service life 100,000 h at

T_a = +25 °C

³⁾ Limit values

⁴⁾ May not exceed or fall short of

V_s tolerances

⁵⁾ Without load

⁶⁾ Signal transit time with resistive load

⁷⁾ With light/dark ratio 1:1

⁸⁾ Do not bend below 0 °C

Scanning distance

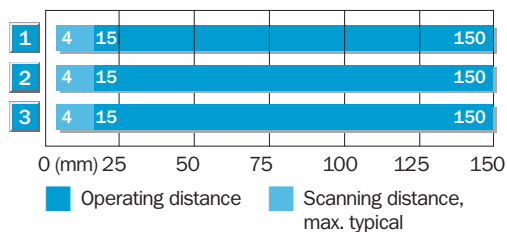

- 1 Scanning range on black, 6 % remission
- 2 Scanning range on grey, 18 % remission
- 3 Scanning range on white, 90 % remission

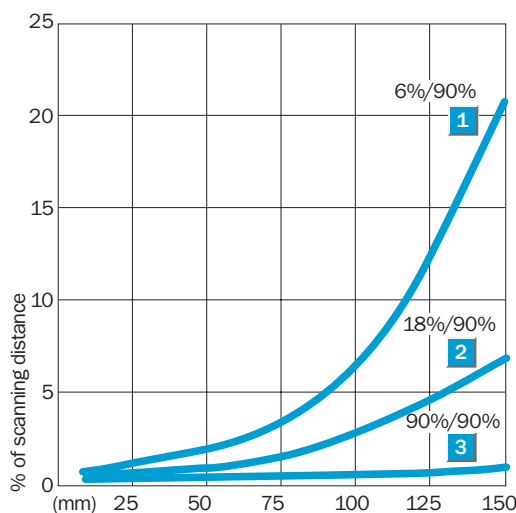

Ordering information

Type	Order no.
WTB4-3N1164	1028090
WTB4-3N1362	1028087
WTB4-3N2162	1028088
WTB4-3N3162	1028089
WTB4-3P1164	1041890
WTB4-3P1362	1028081
WTB4-3P2162	1028084
WTB4-3P2262	1028085
WTB4-3P2264	1028086
WTB4-3P3162	1028082

Additional types on request

Scanning distance
4 ... 150 mm

Photoelectric proximity switch

- Object detection almost irrespective of colour and background consistency
- Reliable operation if devices are installed opposite each other
- Commissioning through simple teach-in function or IO-Link
- Parameters and diagnostics via IO-Link

Dimensional drawing

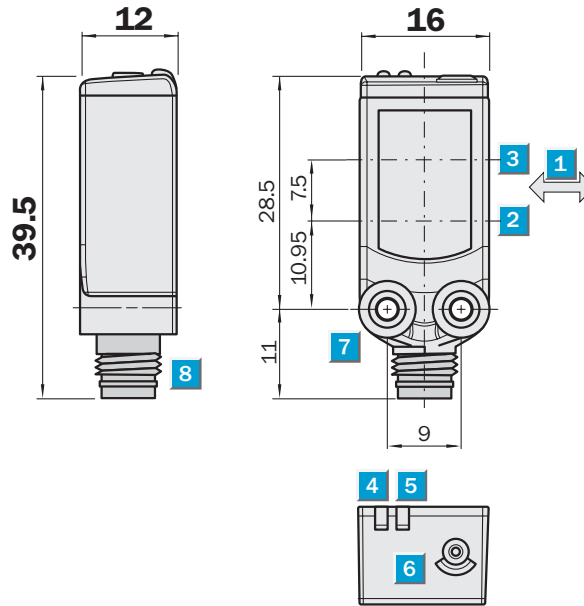

Adjustments possible

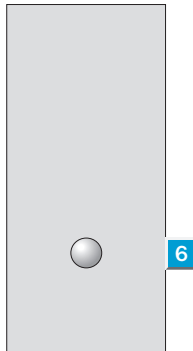

- 1 Standard direction of the material being scanned
- 2 Optical axis, receiver
- 3 Optical axis, sender
- 4 LED indicator yellow, status of received light beam
- 5 LED indicator green, power on
- 6 Teach button
- 7 Mounting hole M3
- 8 Connector



Connection type

WTB4C-3P2264 WTB4C-3P3464

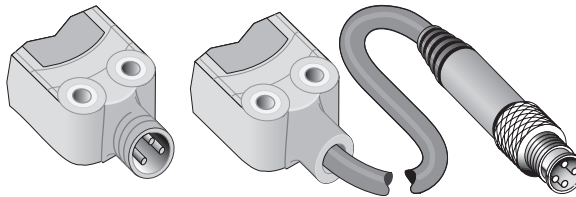

M8, 4-pin

M12, 4-pin

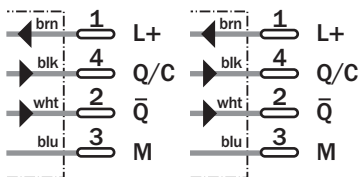

See Accessories chapter

Connector, M12, 4-pin
Connector, M8, 4-pin
Mounting systems

		WTB4C-3	P2264	P3464										
Scanning distance typ. max.	4 ... 150 mm													
Operating distance	15 ... 150 mm													
Adjustment of operating distance	Teach-in: single-teach button Teach-in: via IO-Link													
Communication mode	COM2													
Light source, light type	Pinpoint LED, red light, 660 nm ¹⁾													
Light spot diameter	7 mm at 50 mm distance													
Supply voltage V_s	DC 18 ... 30 V ²⁾													
Ripple	≤ 5 V _{ss} ³⁾													
Power consumption	≤ 30 mA ⁴⁾													
Switching outputs	PNP, Q/C PNP, not Q													
Switching mode	Light-switching ⁵⁾													
Output current I _a max	< 100 mA													
Response time	< 0.65 ms ⁶⁾													
Switching frequency	1,000 Hz ⁷⁾													
Connection type	Connector, M8, 4-pin													
	Cable with plug, M12, 4-pin, PVC, 100 mm ⁸⁾													
VDE protection class	⊠													
Circuit protection	V _s connections reverse-polarity protected / All outputs short-circuit protected / Interference suppression													
Enclosure rating	IP 66, IP 67													
Ambient temperature operation	-40 °C ... +60 °C													
Ambient temperature storage	-40 °C ... +75 °C													
Weight	Ca. 20 g													
Housing material	Bayblend, PMMA													

¹⁾ Average service life 100,000 h at Ta = +25 °C

²⁾ Limit values

³⁾ May not exceed or fall short of V_s tolerances

⁴⁾ Without load

⁵⁾ Parametrisable via IO-Link

⁶⁾ Signal transit time with resistive load in switching mode. Different values possible

in COM2 mode.

⁷⁾ With light/dark ratio 1:1 in switching mode. Different values possible in COM2 mode.

⁸⁾ Do not bend below 0 °C

Scanning distance

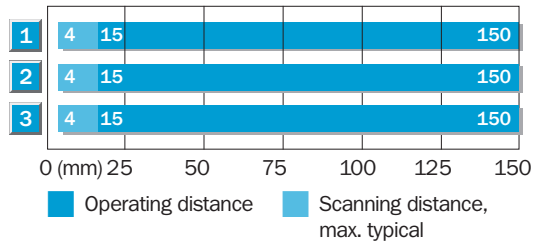

- 1 Scanning range on black, 6 % remission
- 2 Scanning range on grey, 18 % remission
- 3 Scanning range on white, 90 % remission

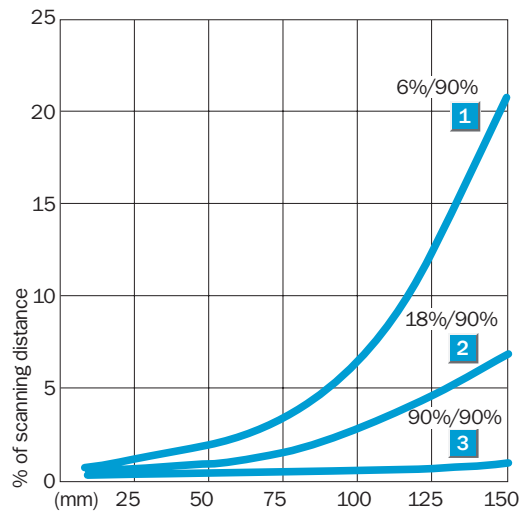

Ordering information

Type	Order no.
WTB4C-3P2264	1028093
WTB4C-3P3464	1040119

Scanning distance
4 ... 50 mm

Photoelectric proximity switch

- Reliable detection of highly transparent and shiny objects at a distance of 20 ... 25 mm
- High-precision setting of scanning distance thanks to 5-turn potentiometer
- Large, homogeneous light spot

Dimensional drawing

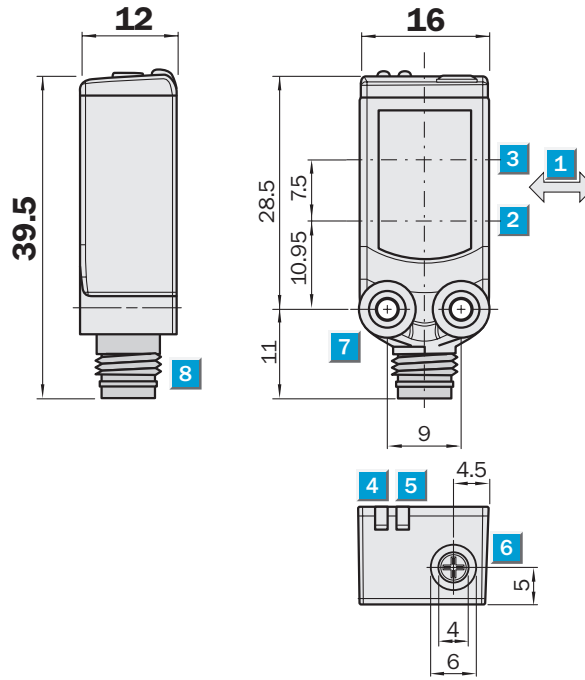

Adjustments possible



- 1 Standard direction of the material being scanned
- 2 Optical axis, receiver
- 3 Optical axis, sender
- 4 LED indicator yellow, status of received light beam
- 5 LED indicator green, power on
- 6 Potentiometer
- 7 Mounting hole M3
- 8 Connector

Connection type

WTV4-3P3121	WTV4-3N2141	WTV4-3P2241	WTV4-3N1341
WTV4-3P3141	WTV4-3P2141		WTV4-3P1321
			WTV4-3P1341

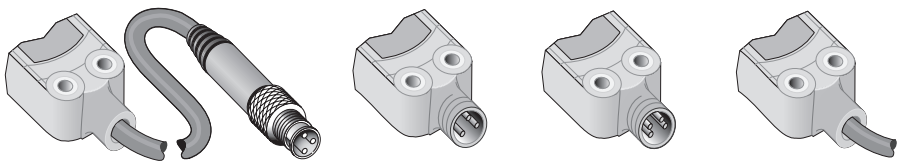

M8, 3-pin

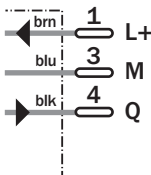

M8, 3-pin

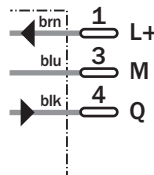

M8, 4-pin

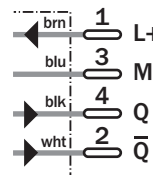

3 x 0.14 mm²

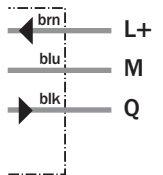

WTV4-3P3441

M12, 4-pin

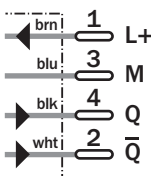

See Accessories chapter

- Connector, M12, 4-pin
- Connector, M8, 3-pin
- Connector, M8, 4-pin
- Mounting systems

WTV4-3		N1341	N2141	P1321	P1341	P2141	P2241	P3121	P3141	P3441
Scanning distance typ. max.	4 ... 50 mm									
Operating distance	15 ... 50 mm									
Adjustment of operating distance	Potentiometer, 5 revolutions									
Light source, light type	Pinpoint LED, red light, 650 nm ¹⁾									
	Pinpoint LED, infrared light, 880 nm ¹⁾									
Light spot diameter	10 mm at 40 mm distance									
Supply voltage V_s	DC 10 ... 30 V ²⁾									
Ripple	< 5 V _{ss} ³⁾									
Power consumption	≤ 30 mA ⁴⁾									
Switching outputs	NPN, Q									
	PNP, Q									
	PNP antivalent									
Switching mode	Light-switching									
	Complementary									
Output current I _a max	≤ 100 mA									
Response time	< 0.5 ms ⁵⁾									
Switching frequency	1,000 Hz ⁶⁾									
Connection type	Cable, PVC, 2 m ⁷⁾									
	Connector, M8, 3-pin									
	Connector, M8, 4-pin									
	Cable with plug, M8, 3-pin, PVC, 100 mm									
	Cable with plug, M12, 4-pin, PVC, 150 mm									
VDE protection class	⊠									
Circuit protection	V _s connections reverse-polarity protected / Output Q and Q not short-circuit protected / Interference suppression									
Enclosure rating	IP 66, IP 67									
Ambient temperature operation	-40 °C ... +60 °C									
Ambient temperature storage	-40 °C ... +75 °C									
Weight	Ca. 20 g									
Housing material	Bayblend, PMMA									

¹⁾ Average service life 100,000 h at Ta = +25 °C
²⁾ Limit values

³⁾ May not exceed or fall short of V_s tolerances
⁴⁾ Without load

⁵⁾ Signal transit time with resistive load
⁶⁾ With light/dark ratio 1:1
⁷⁾ Do not bend below 0 °C

Black-white shift/distance to background

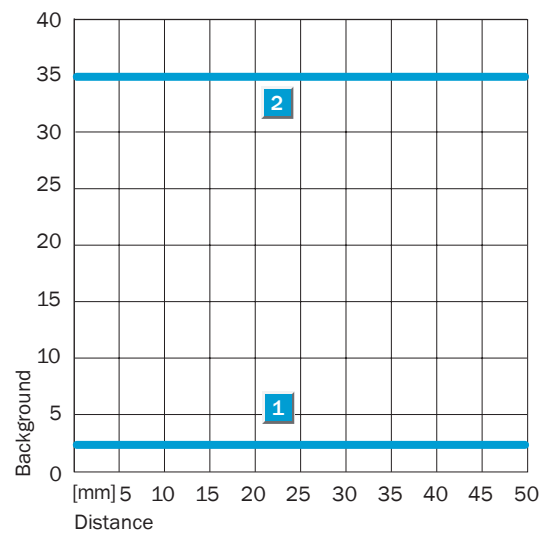

Ordering information	
Type	Order no.
WTV4-3N1341	1028115
WTV4-3N2141	1028116
WTV4-3P1321	1029888
WTV4-3P1341	1028111
WTV4-3P2141	1028113
WTV4-3P2241	1028114
WTV4-3P3121	1042191
WTV4-3P3141	1028112
WTV4-3P3441	1029582

- 1** Black-white shift 90%/6%
- 2** Distance to background detecting transparent objects

Scanning distance
4 ... 150 mm

Photoelectric proximity switch

- Wide-angle light spot with an aperture of 30°
- Reliable detection of objects with slots and holes
- Reliable detection of grid structures

Dimensional drawing

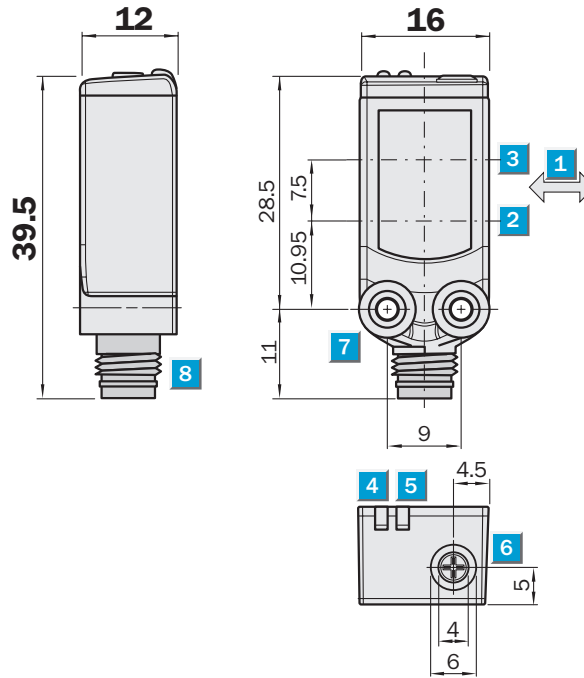

Adjustments possible



- 1 Direction of the sender light line
- 2 Optical axis, sender
- 3 Optical axis, receiver
- 4 LED indicator yellow, status of received light beam
- 5 LED indicator green, power on
- 6 Potentiometer
- 7 Mounting hole M3
- 8 Connector



Connection type

WTB4-3N3171	WTB4-3N2171	WTB4-3P2271	WTB4-3N1371
WTB4-3P3171	WTB4-3P2171		WTB4-3P1371

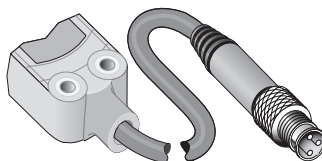

M8, 3-pin

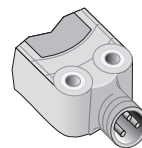
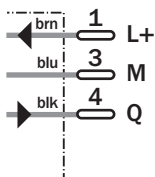

M8, 3-pin

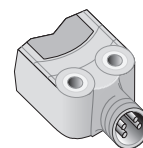
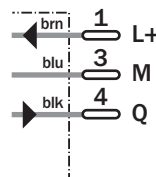

M8, 4-pin

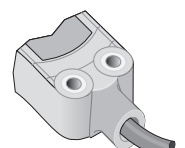
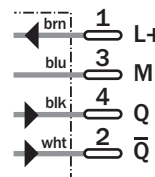

3 x 0.14 mm²

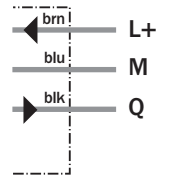

See Accessories chapter

- Connector, M8, 3-pin
- Connector, M8, 4-pin
- Mounting systems

WTB4-3		N1371	N2171	N3171	P1371	P2171	P2271	P3171			
Scanning distance typ. max.	4 ... 150 mm										
Operating distance	15 ... 150 mm										
Adjustment of operating distance	Potentiometer, 5 revolutions										
Light source, light type	Pinpoint LED, red light, 650 nm ¹⁾										
Light spot diameter	5 x 28 mm at 50 mm distance										
Supply voltage V _s	DC 10 ... 30 V ²⁾										
Ripple	< 5 V _{ss} ³⁾										
Power consumption	≤ 30 mA ⁴⁾										
Switching outputs	NPN, Q										
	PNP, Q										
	PNP antivalent										
Switching mode	Light-switching										
	Complementary										
Output current I _a max	≤ 100 mA										
Response time	< 0.5 ms ⁵⁾										
Switching frequency	1,000 Hz ⁶⁾										
Connection type	Cable, PVC, 2 m ⁷⁾										
	Connector, M8, 3-pin										
	Cable with plug, M8, 3-pin, PVC, 100 mm ⁷⁾										
	Connector, M8, 4-pin										
VDE protection class	⊠										
Circuit protection	V _s connections reverse-polarity protected / Output Q and Q not short-circuit protected / Interference suppression										
Enclosure rating	IP 66, IP 67										
Ambient temperature operation	-40 °C ... +60 °C										
Ambient temperature storage	-40 °C ... +75 °C										
Weight	Ca. 20 g										
Housing material	Bayblend, PMMA										

¹⁾ Average service life 100,000 h at Ta = +25 °C
²⁾ Limit values

³⁾ May not exceed or fall short of V_s tolerances
⁴⁾ Without load

⁵⁾ Signal transit time with resistive load
⁶⁾ With light/dark ratio 1:1
⁷⁾ Do not bend below 0 °C

Scanning distance and light spot width

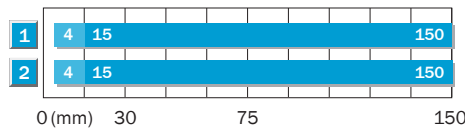

- 1 Scanning range on white, 90 % reflectance
- 2 Scanning range on black, 6 % reflectance

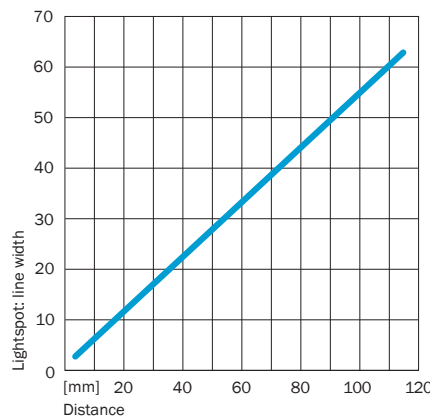

Ordering information

Type	Order no.
WTB4-3N1371	1028125
WTB4-3N2171	1028126
WTB4-3N3171	1041717
WTB4-3P1371	1028121
WTB4-3P2171	1028123
WTB4-3P2271	1042190
WTB4-3P3171	1028122

Minimum detectable object

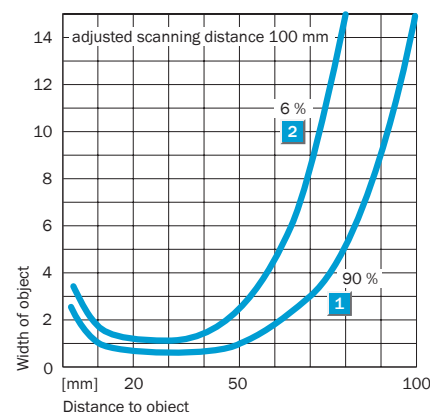
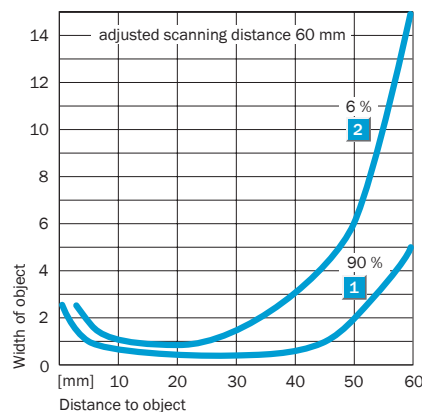

Scanning distance
4 ... 120 mm

Photoelectric proximity switch

- Robust Teflon housing for use in wet and aggressive environments
- Suitable for food applications
- Scanning distance set via teach-in wire
- Background suppression

Dimensional drawing

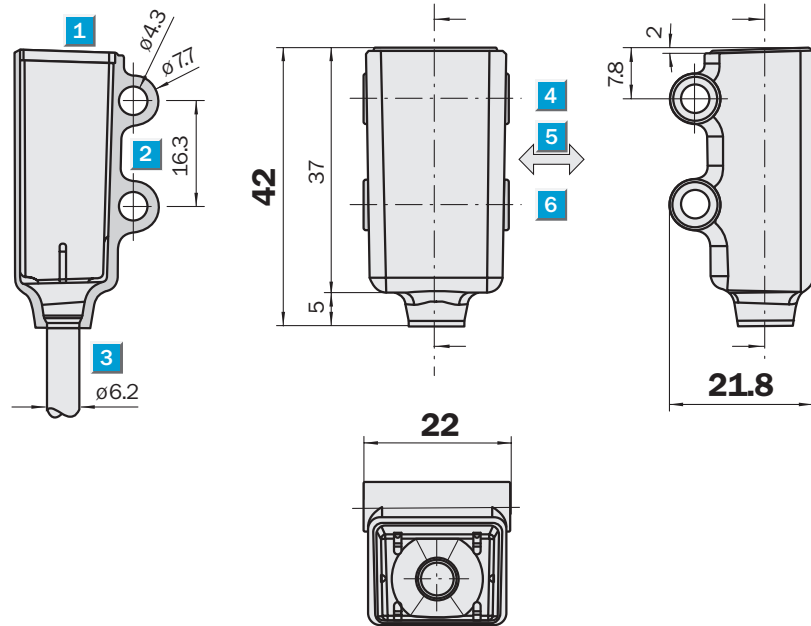

Adjustments possible

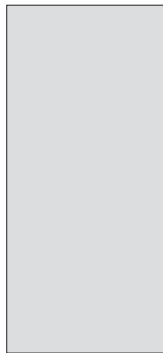

- 1 LED signal
- 2 Mounting hole $\phi 4.3$ mm
- 3 Cable 5 m, $\phi 3.4$ mm, 2 m Teflon coated, $\phi 6.2$ mm
- 4 Optical axis, receiver
- 5 Standard direction of the material being scanned
- 6 Optical axis, sender



Connection type

WTB4T-3N1264
WTB4T-3P1264

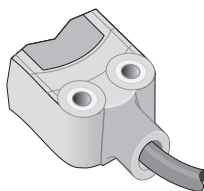

4 x 0.14 mm²

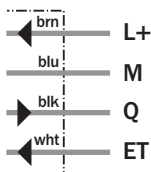

See Accessories chapter
Mounting systems



WTB4T-3		N1264	P1264											
Scanning distance typ. max.	4 ... 120 mm													
Operating distance	15 ... 120 mm													
Adjustment of operating distance	Teach-in: External ¹⁾													
Light source, light type	Pinpoint LED, red light, 650 nm ²⁾													
Light spot diameter	7 mm at 50 mm distance													
Supply voltage V_s	DC 10 ... 30 V ³⁾													
Ripple	< 5 V _{ss} ⁴⁾													
Power consumption	≤ 30 mA ⁵⁾													
Switching outputs	NPN, Q													
	PNP, Q													
Switching mode	Light-switching													
Output current I _a max	≤ 100 mA													
Response time	< 1 ms ⁶⁾													
	< 0.5 ms ⁶⁾													
Switching frequency	500 Hz ⁷⁾													
	1,000 Hz ⁷⁾													
Connection type	Cable, PVC/Teflon coating, 5 m ⁸⁾													
VDE protection class	◇◇													
Circuit protection	V _s connections reverse-polarity protected / Output Q and Q not short-circuit protected / Interference suppression													
Enclosure rating	IP 68, IP 69K													
Ambient temperature operation	-40 °C ... +60 °C													
Ambient temperature storage	-40 °C ... +75 °C													
Weight	Ca. 50 g													
Housing material	PTFE/Teflon													

¹⁾ External teach-in: impuls > 2 s with voltage
V_s for PNP or M for NPN

²⁾ Average service life 100,000 h at

T_a = +25 °C

³⁾ Limit values

⁴⁾ May not exceed or fall short of

V_s tolerances

⁵⁾ Without load

⁶⁾ Signal transit time with resistive load

⁷⁾ With light/dark ratio 1:1

⁸⁾ Do not bend below 0 °C

Ordering information

Type	Order no.
WTB4T-3N1264	1028092
WTB4T-3P1264	1028091

Scanning range
 0 ... 4 m

Photoelectric reflex switch

- Reliable function in restricted spaces thanks to autocollimation
- Small, easily visible, tightly defined light spot
- Robust mounting thanks to M3 metal bushes

Dimensional drawing

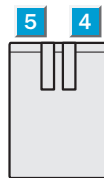
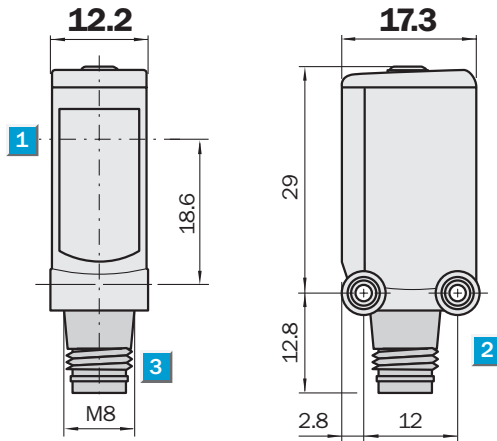

Adjustments possible

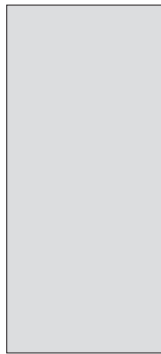

- 1 Optical axis
- 2 Mounting hole M3
- 3 Connector
- 4 LED signal strength indicator green: power on
- 5 LED signal strength indicator orange: status of received light beam



Connection type

WL4S-3E2130	WL4S-3P2230	WL4S-3F3130	WL4S-3E1330
WL4S-3F2130		WL4S-3P3130	WL4S-3N1330
WL4S-3P2130			WL4S-3P1330

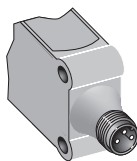

M8, 3-pin

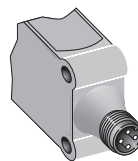

M8, 4-pin

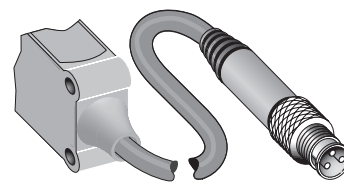

M8, 3-pin

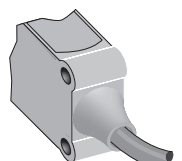

3 x 0.14 mm²

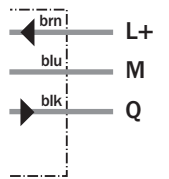
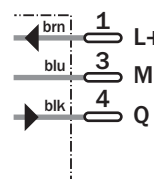
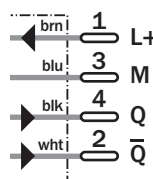
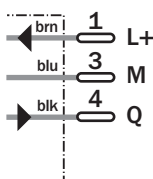

See Accessories chapter

- Connector, M8, 3-pin
- Connector, M8, 4-pin
- Mounting systems
- Reflectors

WL4S-3		E1330	E2130	F2130	F3130	N1330	P1330	P2130	P2230	P3130
Scanning range typ. max.	0 ... 4 m									
Scanning range, recommended	0 ... 2.5 m									
Relating to	Reflector PL80A									
Light source, light type	Pinpoint LED, red light, 650 nm ¹⁾									
Light spot diameter	45 mm at 1.5 m distance									
Polarisation filter	✓									
Supply voltage V _s	DC 10 ... 30 V ²⁾									
Ripple	≤ 5 V _{ss} ³⁾									
Power consumption	≤ 20 mA ⁴⁾									
Switching outputs	NPN, Q									
	PNP, Q									
	PNP antivalent									
Switching mode	Dark-switching									
	Light-switching									
	Complementary									
Output current I _a max	≤ 100 mA									
Response time	< 0.5 ms ⁵⁾									
Switching frequency	1,000 Hz ⁶⁾									
Connection type	Cable, PVC, 2 m ⁷⁾									
	Connector, M8, 3-pin									
	Cable with plug, M8, 3-pin, PVC, 100 mm ⁷⁾									
	Connector, M8, 4-pin									
Circuit protection	V _s connections reverse-polarity protected / Output Q and Q not short-circuit protected / Interference suppression									
Enclosure rating	IP 66, IP 67									
Ambient temperature operation	-40 °C ... +60 °C									
Ambient temperature storage	-40 °C ... +75 °C									
Weight	Ca. 30 g									
Housing material	Bayblend, PMMA									

¹⁾ Average service life 100,000 h at Ta = +25 °C

²⁾ Limit values, reverse-polarity protected

operation in short-circuit protected network max. 8 A

³⁾ May not exceed or fall short of

V_s tolerances

⁴⁾ Without load

⁵⁾ Signal transit time with resistive load

⁶⁾ With light/dark ratio 1:1

⁷⁾ Do not bend below 0 °C

Scanning range and operating reserve

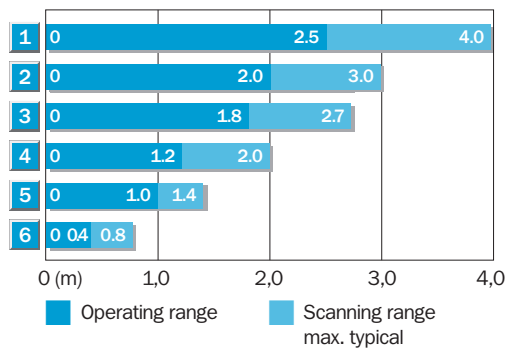

Reflector type	Operating range
1	PL80A 0 ... 2.5 m
2	PL250F 0 ... 2.0 m
3	PL40A 0 ... 1.8 m
4	PL20F 0 ... 1.2 m
5	PL10F 0 ... 1.0 m
6	REF-IRF-56 0 ... 0.4 m

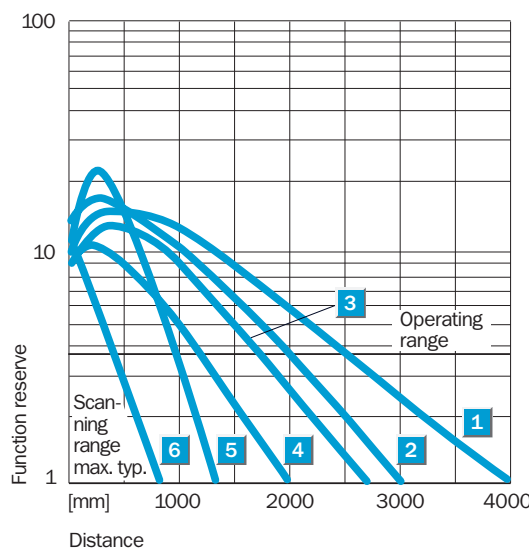

Ordering information

Type	Order no.
WL4S-3E1330	1042072
WL4S-3E2130	1042071
WL4S-3F2130	1042065
WL4S-3F3130	1042067
WL4S-3N1330	1042073
WL4S-3P1330	1042068
WL4S-3P2130	1042069
WL4S-3P2230	1042066
WL4S-3P3130	1042070



Scanning range
 0 ... 5 m
Photoelectric reflex switch

- Reliable function in restricted spaces thanks to autocollimation
- Small, easily visible, tightly defined light spot
- Quick and easy commissioning through teach-in function
- Robust mounting thanks to M3 metal bushes

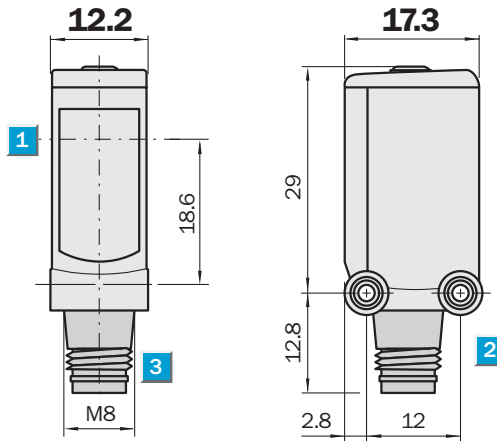
Dimensional drawing

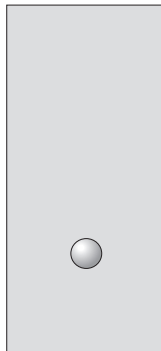

Adjustments possible



- 1 Optical axis
- 2 Mounting hole M3
- 3 Connector
- 4 LED signal strength indicator green: power on
- 5 LED signal strength indicator orange: status of received light beam
- 6 Teach button

Connection type

WL4S-3E1332
WL4S-3F1332
WL4S-3N1332

WL4S-3V2232

WL4S-3E2132
WL4S-3F2132
WL4S-3P2132

WL4S-3F3132

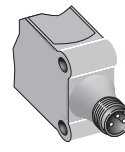
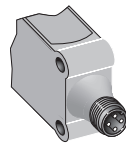
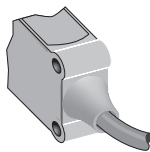

3 x 0.14 mm²

M8, 4-pin

M8, 3-pin

M8, 3-pin

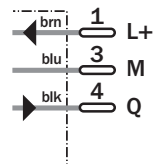
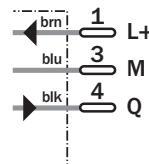
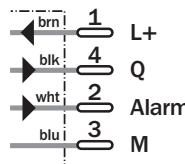
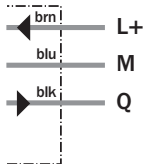

WL4S-3W1132
4 x 0.14 mm²

WL4S-3P2232
M8, 4-pin

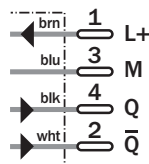
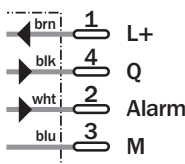

See Accessories chapter

- Connector, M8, 3-pin
- Connector, M8, 4-pin
- Mounting systems
- Reflectors

	WL4S-3	E1332	E2132	F1332	F2132	F3132	N1332	P2132	P2232	V2232	W113
Scanning range typ. max.	0 ... 5 m										
Scanning range, recommended	0 ... 3 m										
Relating to	Reflector PL80A										
Light source, light type	Pinpoint LED, red light, 650 nm ¹⁾										
Light spot diameter	45 mm at 1.5 m distance										
Polarisation filter	✓										
Supply voltage V_s	DC 10 ... 30 V ²⁾										
Ripple	≤ 5 V _{ss} ³⁾										
Power consumption	≤ 20 mA ⁴⁾										
Switching outputs	NPN, Q										
	PNP, Q										
	PNP antivalent										
	PNP, Q and alarm										
	NPN, Q and alarm										
Switching mode	Dark-switching										
	Light-switching										
	Complementary										
Output current I _a max	≤ 100 mA										
Response time	< 0.5 ms ⁵⁾										
Switching frequency	1,000 Hz ⁶⁾										
Alarm output	Pre-failure signalling output										
Connection type	Cable, PVC, 2 m ⁷⁾										
	Connector, M8, 3-pin										
	Cable with plug, M8, 3-pin, PVC, 100 mm ⁷⁾										
	Connector, M8, 4-pin										
Circuit protection	V _s connections reverse-polarity protected / Output Q and Q not short-circuit protected / Interference suppression										
Enclosure rating	IP 66, IP 67										
Ambient temperature operation	-40 °C ... +60 °C										
Ambient temperature storage	-40 °C ... +75 °C										
Weight	Ca. 30 g										
Housing material	Bayblend, PMMA										

¹⁾ Average service life 100,000 h at Ta = +25 °C

²⁾ Limit values, reverse-polarity protected

operation in short-circuit protected network max. 8 A

³⁾ May not exceed or fall short of

V_s tolerances

⁴⁾ Without load

⁵⁾ Signal transit time with resistive load

⁶⁾ With light/dark ratio 1:1

⁷⁾ Do not bend below 0 °C

Teach-in function

■ Programming via teach-in button.

■ Easy programming:

Position reflector in the beam path, press button, ready:

LED confirms teach-in operation.

Double reseed via switching threshold.

Scanning range and operating reserve

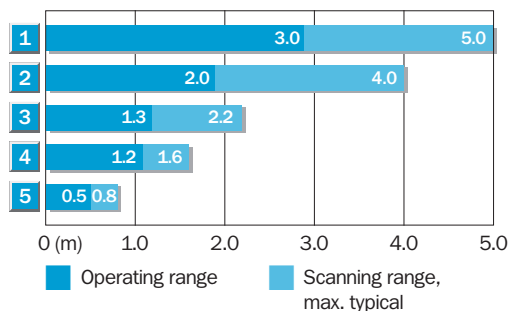

Reflector type	Operating range
1	PL80A 0 ... 3.0 m
2	PL40A 0 ... 2.0 m
3	PL20A 0 ... 1.3 m
4	PL10F 0 ... 1.2 m
5	REF-IRF-56 0 ... 0.5 m

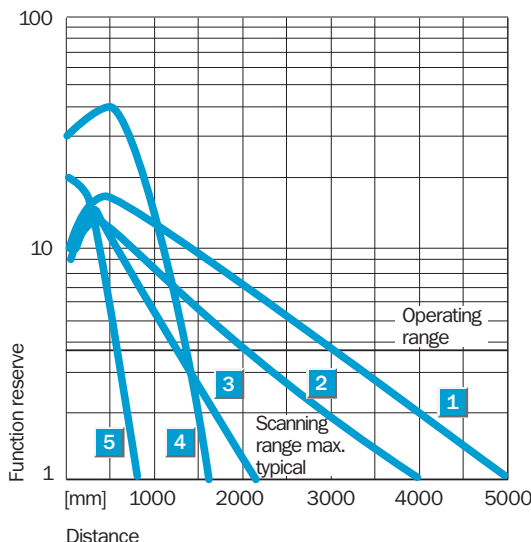

Ordering information

Type	Order no.
WL4S-3E1332	1042081
WL4S-3E2132	1042080
WL4S-3F1332	1042076
WL4S-3F2132	1042074
WL4S-3F3132	1042075
WL4S-3N1332	1042082
WL4S-3P2132	1042077
WL4S-3P2232	1042078
WL4S-3V2232	1042079
WL4S-3W1132	1042083

Photoelectric reflex switch, WLG4S-3, for transparent objects



Scanning range
 0 ... 5 m
Photoelectric reflex switch

- Continuous adaptation of the switching threshold in case of lens contamination
- Stable operation thanks to temperature compensation
- Small, easily visible, tightly defined light spot
- Quick and easy commissioning through teach-in function
- Detection of glass objects with an attenuation of > 8%

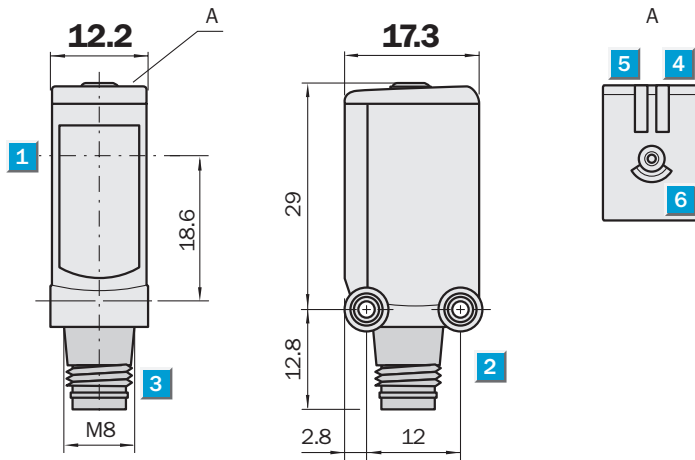
Dimensional drawing

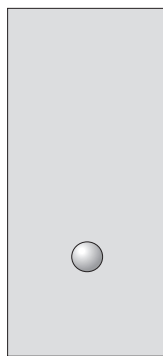

Adjustments possible



- 1 Optical axis
- 2 Mounting hole M3
- 3 Connector
- 4 LED signal strength indicator green: power on
- 5 LED signal strength indicator orange: status of received light beam
- 6 Teach button

Connection type

WLG4S-3F2234 WLG4S-3E1134 WLG4S-3W1132 WLG4S-3V2232

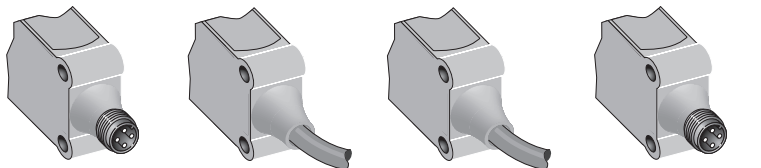

M8, 4-pin 3 x 0,14 mm² 4 x 0,14 mm² M8, 4-pin

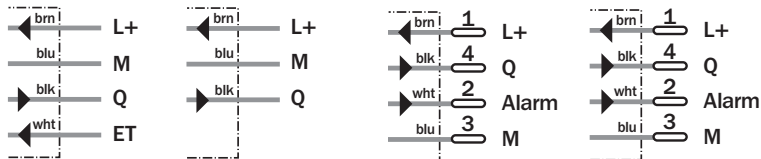

WLG4S-3P2232 WLG4S-3F3132 / WLG4S-3P3132 WLG4S-3F3234

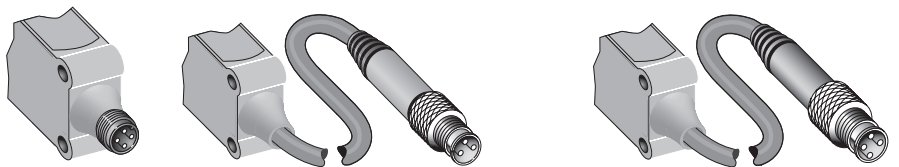

M8, 4-pin M8, 3-pin M8, 4-pin

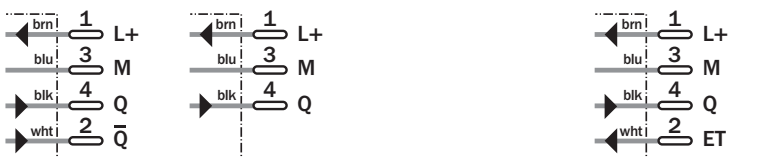

See Accessories chapter
 Connector, M8, 4-pin
 Mounting systems
 Reflectors

WLG4S-3		E1134	F2234	V2232	W113	P2232	P3132	F3132	F3234		
Detection of transparent objects	✓										
Attenuation along light beam	> 8 %										
Scanning range typ. max.	0 ... 5 m										
Scanning range, recommended	0 ... 3 m										
Relating to	Reflector PL80A										
Sensitivity adjustment	Teach-in: single-teach button										
	Teach-in: single-teach button & cable										
Light source, light type	Pinpoint LED, red light, 650 nm ¹⁾										
Light spot diameter	45 mm at 1.5 m distance										
Polarisation filter	✓										
Supply voltage V_s	DC 10 ... 30 V ²⁾										
Ripple	≤ 5 Vss ³⁾										
Power consumption	≤ 20 mA ⁴⁾										
Switching outputs	NPN, Q										
	PNP, Q										
Switching mode	Dark-switching										
Output current I _a max	≤ 100 mA										
Response time	< 0.5 ms ⁵⁾										
Switching frequency	1,000 Hz ⁶⁾										
Alarm output	Pre-failure signalling output										
Connection type	Cable, PVC, 2 m ⁷⁾										
	Connector, M8, 3-pin,										
	Cable with plug, M8, 3-pin, 100 mm ⁷⁾										
	Cable with plug, M8, 4-pin, 100 mm ⁷⁾										
Circuit protection	V _s connections reverse-polarity protected / Output Q and Q not short-circuit protected / Interference suppression										
Enclosure rating	IP 66, IP 67										
Ambient temperature operation	-40 °C ... +60 °C										
Ambient temperature storage	-40 °C ... +75 °C										
Weight	Ca. 30 g										
Housing material	Bayblend, PMMA										

¹⁾ Average service life 100,000 h at Ta = +25 °C
²⁾ Limit values, reverse-polarity protected
³⁾ May not exceed or fall short of
⁴⁾ Without load
⁵⁾ Signal transit time with resistive load
⁶⁾ With light/dark ratio 1:1
⁷⁾ Do not bend below 0 °C

Teach-in function

Programming via teach-in button
 Standard mode (switching threshold adaptation): sensor adjusts the switching threshold to the ambient conditions. Sensor has clear sight of the reflector.
 No object in the beam path: press teach-in button for > 2 s until yellow LED indicator lights up again. Sensor is ready to operate.

Switch off switching threshold adaptation: sensor works statically with a switching threshold of 50 %. Sensor has clear sight of the reflector. No object in the beam path: press teach-in button for > 8s until yellow LED indicator flashes twice. Sensor is ready to operate.

Scanning range and operating reserve

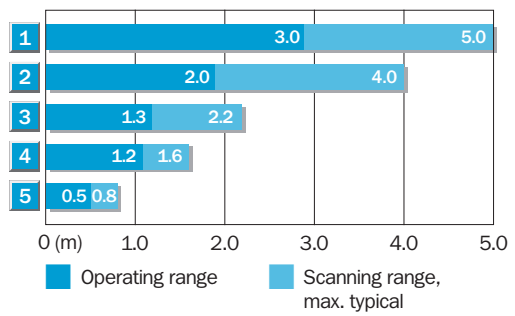

Reflector type	Operating range
1 PL80A	0 ... 3.0 m
2 PL40A	0 ... 2.0 m
3 PL20A	0 ... 1.3 m
4 PL10F	0 ... 1.2 m
5 REF-IRF-56	0 ... 0.5 m

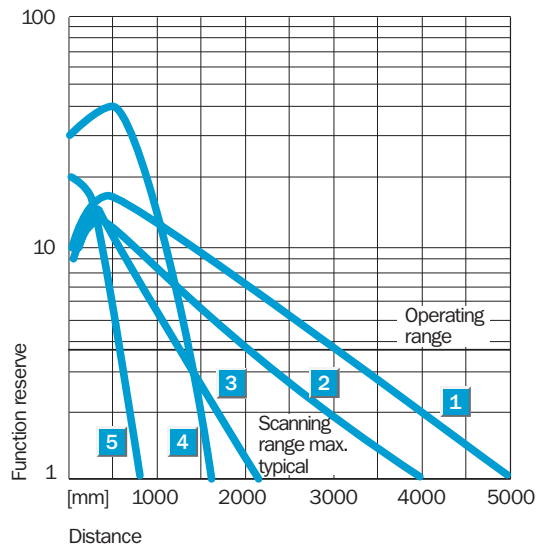

Order information	
Type	Order no.
WLG4S-3E1134	1042085
WLG4S-3F2234	1042084
WLG4S-3V2232	1042087
WLG4S-3W1132	1042086
WLG4S-3P2232	1044186
WLG4S-3P3132	1043839
WLG4S-3F3132	1043838
WLG4S-3F3234	1043840

Scanning range
0.01 ... 4 m

Photoelectric reflex switch

- Fast and safe alignment through high visibility light spot
- Fast commissioning. Connect, align, ready!
- Easy assembly in slots and guide rails

Dimensional drawing

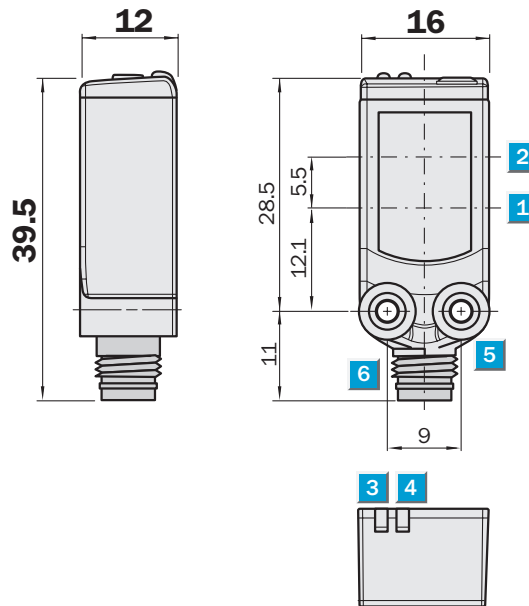

Adjustments possible

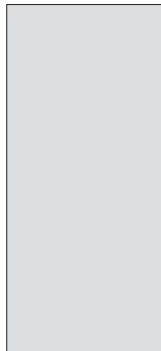

- 1 Centre of optical axis, sender
- 2 Centre of optical axis, receiver
- 3 LED signal strength indicator yellow: status of received light beam
- 4 LED signal strength indicator green: power on
- 5 Mounting hole M3
- 6 Connector



Connection type

WL4-3F3130	WL4-3E2130	WL4-3P2230	WL4-3E1330
WL4-3N3130	WL4-3F2130		WL4-3F1330
WL4-3P3130	WL4-3P2130		WL4-3P1330

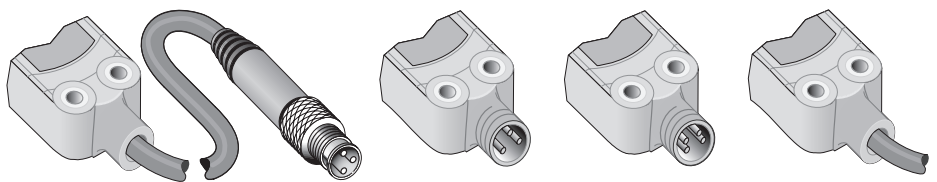

M8, 3-pin

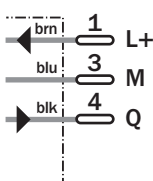

M8, 3-pin

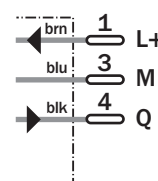

M8, 4-pin

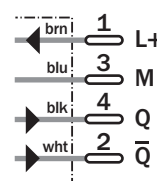

3 x 0.14 mm²

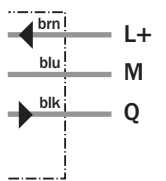

See Accessories chapter

- Connector, M8, 3-pin
- Connector, M8, 4-pin
- Mounting systems
- Reflectors

WL4-3		E1330	E2130	F1330	F2130	F3130	N3130	P1330	P2130	P2230	P3130
Scanning range typ. max.	0.01 ... 4 m										
Scanning range, recommended	0.02 ... 3.5 m										
Relating to	Reflector PL80A										
Light source, light type	Pinpoint LED, red light, 650 nm ¹⁾										
Light spot diameter	75 mm at 1.5 m distance										
Polarisation filter	✓										
Supply voltage V_s	DC 10 ... 30 V ²⁾										
Ripple	≤ 5 V _{ss} ³⁾										
Power consumption	≤ 20 mA ⁴⁾										
Switching outputs	NPN, Q										
	PNP, Q										
	PNP antivalent										
Switching mode	Dark-switching										
	Light-switching										
Output current I _a max	≤ 100 mA										
Response time	< 0.5 ms ⁵⁾										
Switching frequency	1,000 Hz ⁶⁾										
Connection type	Cable, PVC, 2 m ⁷⁾										
	Connector, M8, 3-pin										
	Cable with plug, M8, 3-pin, 100 mm ⁷⁾										
	Connector, M8, 4-pin										
Circuit protection	V _s connections reverse-polarity protected / Output Q and Q not short-circuit protected / Interference suppression										
Enclosure rating	IP 66, IP 67										
Ambient temperature operation	-40 °C ... +60 °C										
Ambient temperature storage	-40 °C ... +75 °C										
Weight	Ca. 30 g										
Housing material	Bayblend, PMMA										

¹⁾ Average service life 100,000 h at Ta = +25 °C

²⁾ Limit values, reverse-polarity protected

operation in short-circuit protected network max. 8 A

³⁾ May not exceed or fall short of

V_s tolerances

⁴⁾ Without load

⁵⁾ Signal transit time with resistive load

⁶⁾ With light/dark ratio 1:1

⁷⁾ Do not bend below 0 °C

Scanning range and operating reserve

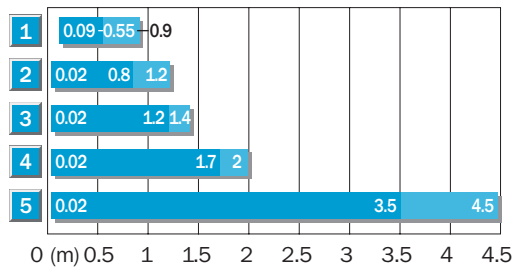

Reflector type	Operating range
1 REF-IRF-56	0.09 ... 0.55 m
2 PL10F	0.02 ... 0.8 m
3 PL20A	0.02 ... 1.2 m
4 PL40A	0.02 ... 1.7 m
5 PL80A	0.02 ... 3.5 m

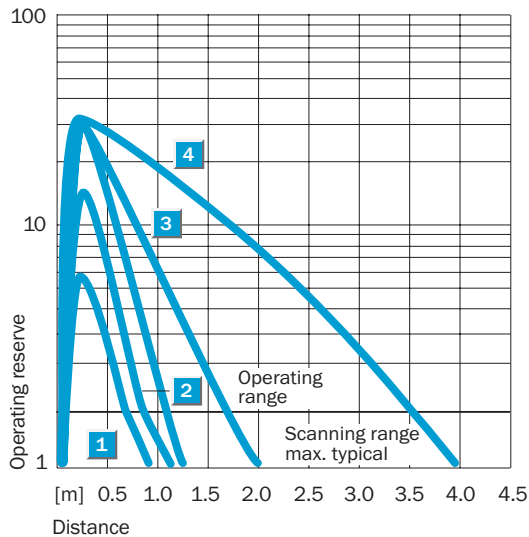

Ordering information	
Type	Order no.
WL4-3E1330	1028156
WL4-3E2130	1028158
WL4-3F1330	1028152
WL4-3F2130	1028155
WL4-3F3130	1028153
WL4-3N3130	1028150
WL4-3P1330	1028143
WL4-3P2130	1028146
WL4-3P2230	1028147
WL4-3P3130	1028144

Scanning range
 0.01 ... 4 m
Photoelectric reflex switch

- Fast and safe alignment through high visibility light spot
- Detection of glass objects with an attenuation of > 8%
- Sensitivity setting via wire

Dimensional drawing

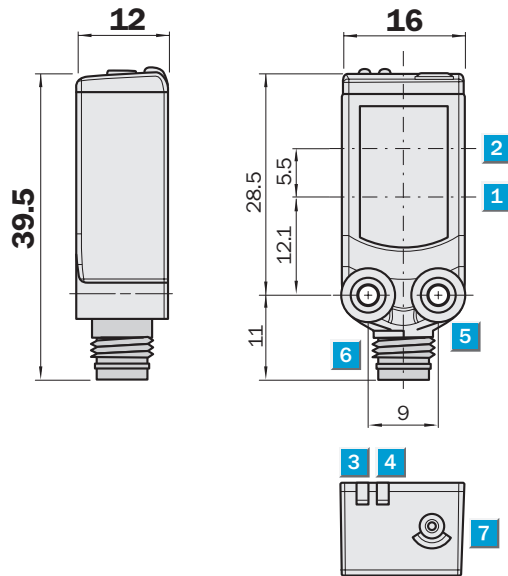

Adjustments possible

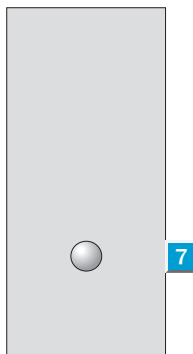

- 1 Centre of optical axis, sender
- 2 Centre of optical axis, receiver
- 3 LED signal strength indicator orange: status of received
- 4 LED signal strength indicator green: power on
- 5 Mounting hole M3
- 6 Connector
- 7 Teach button

Connection type

WLG4-3E1134	WLG4-3E2132	WLG4-3F2234	WLG4-3E1332
	WLG4-3F2132		WLG4-3P1332
	WLG4-3P2132		

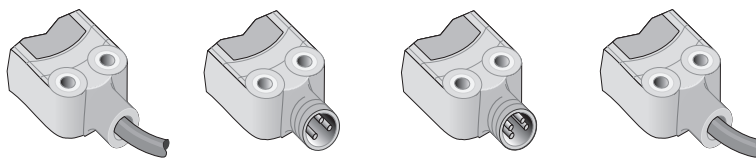

4 x 0,14 mm² M8, 3-pin M8, 4-pin 3 x 0,14 mm²

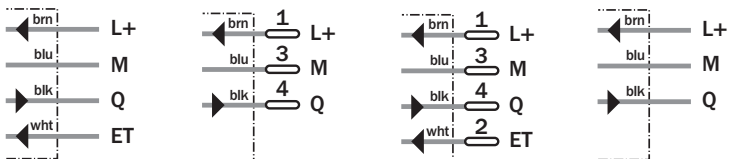

WLG4-3F3132 WLG4-3F3234

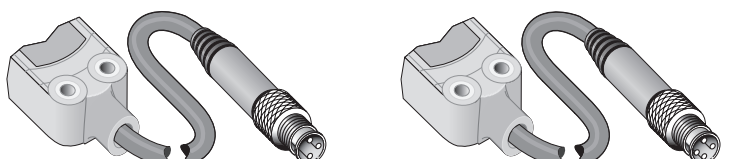

M8, 3-pin M8, 4-pin



See Accessories chapter

Connector, M8, 3-pin

Connector, M8, 4-pin

Mounting systems

WLG4-3		E1134	E1332	E2132	F2132	F2234	F3132	F3234	P1332	P2132
Detection of transparent objects	✓									
Attenuation along light beam	> 8 %									
Scanning range typ. max.	0.01 ... 4 m									
Scanning range, recommended	0.02 ... 3.5 m									
Relating to	Reflector PL80A									
Sensitivity adjustment	Teach-in: single-teach button & cable									
	Teach-in: single-teach button									
Light source, light type	Pinpoint LED, red light, 650 nm ¹⁾									
Light spot diameter	75 mm at 1.5 m distance									
Polarisation filter	✓									
Supply voltage V_s	DC 10 ... 30 V ²⁾									
Ripple	≤ 5 Vss ³⁾									
Power consumption	≤ 20 mA ⁴⁾									
Switching outputs	NPN, Q									
	PNP, Q									
Switching mode	Dark-switching									
	Light-switching									
Output current I _a max	≤ 100 mA									
Response time	< 0.5 ms ⁵⁾									
Switching frequency	1,000 Hz ⁶⁾									
Connection type	Cable, PVC, 2 m ⁷⁾									
	Connector, M8, 3-pin									
	Connector, M8, 4-pin									
	Cable with plug, M8, 3-pin, 100 mm ⁷⁾									
	Cable with plug, M8, 4-pin, 100 mm ⁷⁾									
Circuit protection	V _s connections reverse-polarity protected / Output Q and Q not short-circuit protected / Interference suppression									
Enclosure rating	IP 66, IP 67									
Ambient temperature operation	-40 °C ... +60 °C									
Ambient temperature storage	-40 °C ... +75 °C									
Weight	Ca. 30 g									
Housing material	Bayblend, PMMA									

¹⁾ Average service life 100,000 h at Ta = +25 °C
²⁾ Limit values, reverse-polarity protected
³⁾ May not exceed or fall short of
⁴⁾ Without load
⁵⁾ Signal transit time with resistive load
⁶⁾ With light/dark ratio 1:1
⁷⁾ Do not bend below 0 °C

Teach-in-Funktion

- Programming via teach-in button.
- Easy programming:
Position reflector in the beam path, press button, ready:
LED confirms teach-in operation.
- Two operating modes:
Standard setting: short Teach-in period (< 8 s); for standard applications;
approx. double reserve via switching threshold
Fine adjustment: long Teach-in period (> 8 s); for precise applications,
transparent objects. Small switching hysteresis.

Scanning range and operating reserve

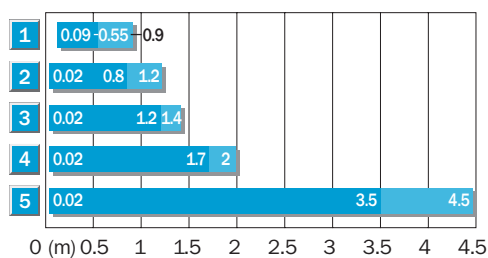

Reflector type	Operating range
1 REF-IRF-56	0.09 ... 0.55 m
2 PL10F	0.02 ... 0.8 m
3 PL20A	0.02 ... 1.2 m
4 PL40A	0.02 ... 1.7 m
5 PL80A	0.02 ... 3.5 m

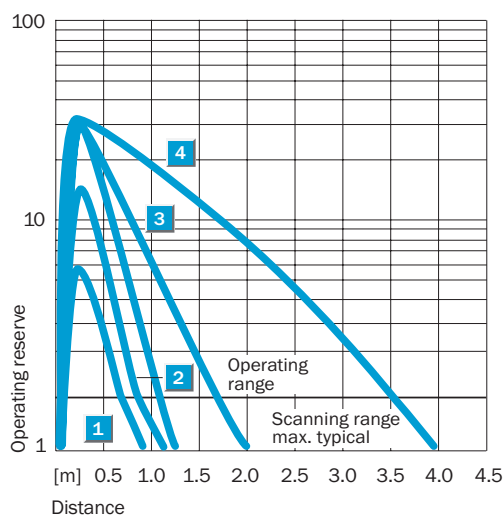

Ordering information

Type	Order no.
WLG4-3E1134	1028133
WLG4-3E1332	1028131
WLG4-3E2132	1028132
WLG4-3F2132	1028127
WLG4-3F2234	1028130
WLG4-3F3132	1028128
WLG4-3F3234	1028129
WLG4-3P1332	1042844
WLG4-3P2132	1029567

Scanning range
 0.01 ... 1.6 m
Photoelectric reflex switch

- Fast and safe alignment through high visibility light spot
- Detection of PET bottles and foils with an attenuation of > 8%
- Sensitivity setting via wire

Dimensional drawing

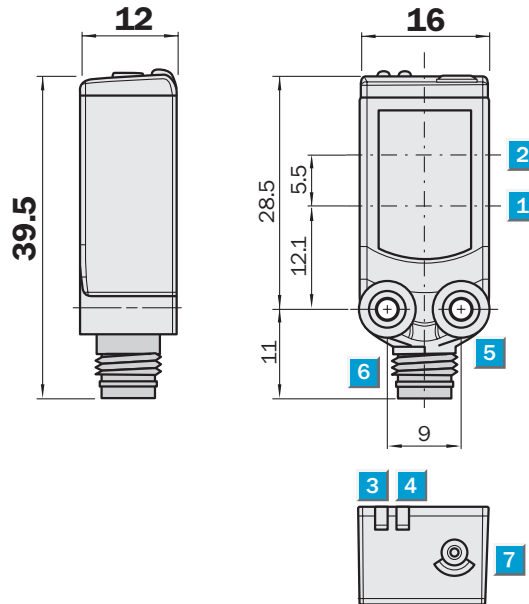

Adjustments possible

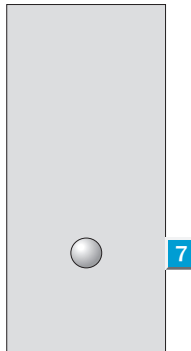

- 1 Centre of optical axis, sender
- 2 Centre of optical axis, receiver
- 3 LED signal strength indicator orange: status of received light beam
- 4 LED signal strength indicator green: power on
- 5 Mounting hole M3
- 6 Connector
- 7 Teach button

Connection type

WLG4-3E1184	WLG4-3F2182	WLG4-3F2284	WLG4-3E1382
WLG4-3P1482	WLG4-3P2182		WLG4-3N1382

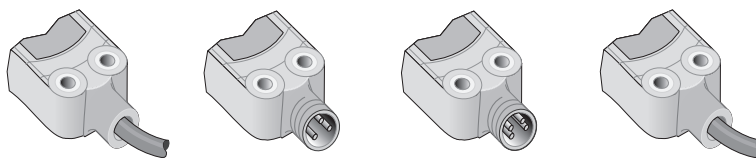

4 x 0,14 mm² M8, 3-pin M8, 4-pin 3 x 0,14 mm²

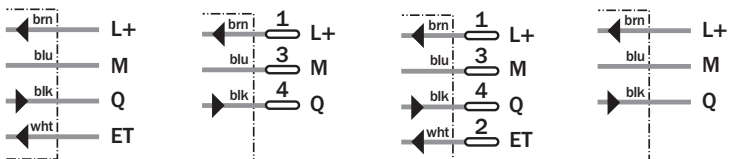

WLG4-3F3182

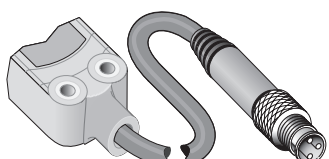

M8, 3-pin

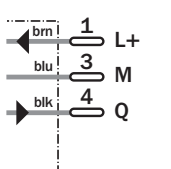

See Accessories chapter
 Connector, M8, 3-pin
 Connector, M8, 4-pin
 Mounting systems

WLG4-3		E1184	E1382	F2182	F2284	F3182	N1382	P1482	P2182		
Detection of transparent objects	✓										
Attenuation along light beam	> 8 %										
Scanning range typ. max.	0.01 ... 1.6 m										
Scanning range, recommended	0.02 ... 0.9 m										
Relating to	Reflector PL80A										
Sensitivity adjustment	Teach-in: single-teach button & cable Teach-in: single-teach button										
Light source, light type	Pinpoint LED, red light, 650 nm ¹⁾										
Light spot diameter	180 mm at 1.5 m distance										
Supply voltage V_s	DC 10 ... 30 V ²⁾										
Ripple	≤ 5 V _{ss} ³⁾										
Power consumption	≤ 20 mA ⁴⁾										
Switching outputs	NPN, Q PNP, Q										
Switching mode	Dark-switching										
Output current I _a max	≤ 100 mA										
Response time	< 0.5 ms ⁵⁾										
Switching frequency	1,000 Hz ⁶⁾										
Connection type	Cable, PVC, 2 m ⁷⁾ Cable, PVC, 5 m ⁷⁾										
Connection type	Connector, M8, 3-pin Connector, M8, 4-pin Cable with plug, M8, 3-pin, 100 mm										
Circuit protection	V _s connections reverse-polarity protected / Output Q and Q not short-circuit protected / Interference suppression										
Enclosure rating	IP 66, IP 67										
Ambient temperature operation	-40 °C ... +60 °C										
Ambient temperature storage	-40 °C ... +75 °C										
Weight	Ca. 30 g										
Housing material	Bayblend, PMMA										

¹⁾ Average service life 100,000 h at Ta = +25 °C
²⁾ Limit values, reverse-polarity protected
³⁾ May not exceed or fall short of
⁴⁾ Without load
⁵⁾ Signal transit time with resistive load
⁶⁾ With light/dark ratio 1:1
⁷⁾ Do not bend below 0 °C

Teach-in function

- Programming via teach-in button.
- Easy programming:
Position reflector in the beam path, press button, ready:
LED confirms teach-in operation.
- Two operating modes:
Standard setting: short Teach-in period (< 8 s); for standard applications; approx. double reserve via switching threshold
Fine adjustment: long Teach-in period (> 8 s); for precise applications, transparent objects. Small switching hysteresis.

Scanning range and operating reserve

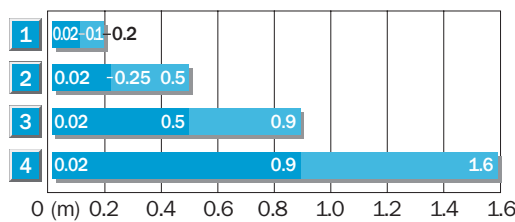

Reflector type	Operating range
1 PL10F	0.02 ... 0.1 m
2 PL20A	0.02 ... 0.25 m
3 PL40A	0.02 ... 0.5 m
4 PL80A	0.02 ... 0.9 m

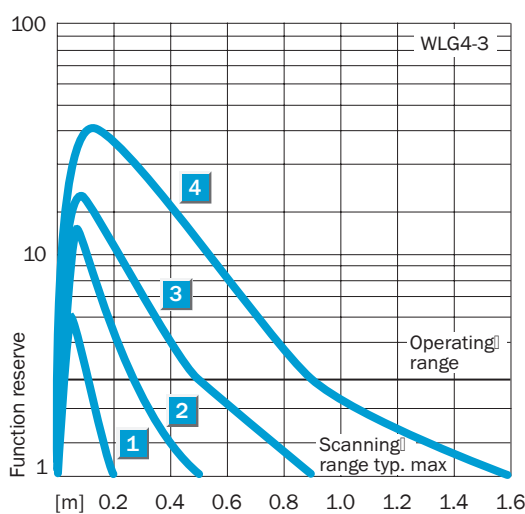

Ordering information	
Type	Order no.
WLG4-3E1184	1028140
WLG4-3E1382	1028138
WLG4-3F2182	1028134
WLG4-3F2284	1028137
WLG4-3F3182	1028135
WLG4-3N1382	1040493
WLG4-3P1482	1029897
WLG4-3P2182	1044179

Scanning range
0 ... 5 m

Through-beam photoelectric

- Fast and reliable alignment through brilliant light spot
- Assembly of several pairs in tight environments due to a tightly defined small light spot
- Robust mounting thanks to M3 metal bushes

Dimensional drawing

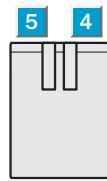
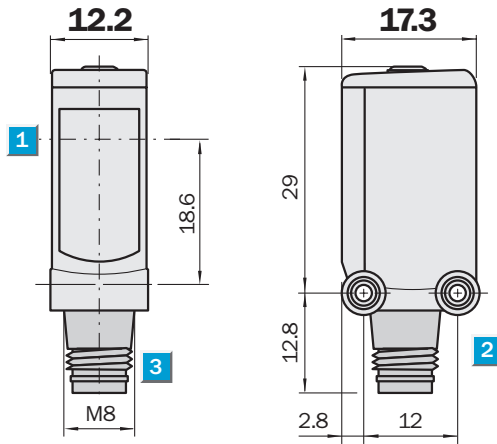

Adjustments possible

- Centre of optical axis
- LED signal strength indicator orange: status of received light beam
- LED signal strength indicator green: power on
- Mounting hole M3
- Connector



Connection type

WSE4S-3E2130
WSE4S-3F2130
WSE4S-3P2130

WSE4S-3F3130

WSE4S-3E1330
WSE4S-3F1330
WSE4S-3N1330

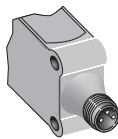

Sender M8, 3-pin

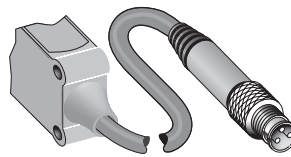
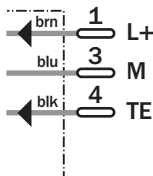

Sender M8, 3-pin

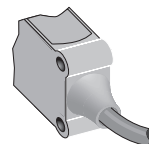
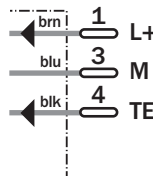

Sender 3 x 0.14 mm²

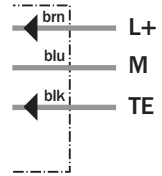

Receiver M8, 3-pin

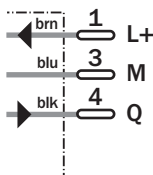

Receiver M8, 3-pin

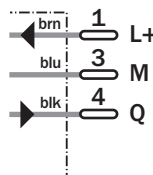

Receiver 3 x 0.14 mm²

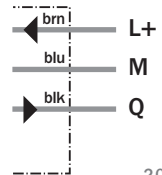

See Accessories chapter

Connector, M8, 3-pin

Mounting systems

WSE4S-3		E1330	E2130	F1330	F2130	F3130	N1330	P2130			
Scanning range typ. max.	0 ... 5 m										
Scanning range, recommended	0 ... 4.5 m										
Light source, light type	Pinpoint LED, red light, 650 nm ¹⁾										
Light spot diameter	130 mm at 2.0 m distance										
Supply voltage V_s	DC 10 ... 30 V ²⁾										
Ripple	≤ 5 Vss ³⁾										
Power consumption, sender	≤ 20 mA										
Power consumption, receiver	≤ 20 mA										
Switching outputs	NPN, Q										
	PNP, Q										
Switching mode	Dark-switching										
	Light-switching										
Output current I _a max	≤ 100 mA										
Response time	2.5 ms ⁴⁾										
Switching frequency	200 Hz ⁵⁾										
Test input sender off	TE to 0 V										
Connection type	Cable, PVC, 2 m ⁶⁾										
	Connector, M8, 3-pin										
	Cable with plug, M8, 3-pin, PVC, 100 mm ⁶⁾										
Circuit protection	V _s connections reverse-polarity protected / Output Q and Q not short-circuit protected / Interference suppression										
Enclosure rating	IP 66, IP 67										
Ambient temperature operation	-40 °C ... +60 °C										
Ambient temperature storage	-40 °C ... +70 °C										
Weight	Ca. 40 g										
Housing material	Bayblend, PMMA										

¹⁾ Average service life 100,000 h at Ta = +25 °C

²⁾ Limit values, reverse-polarity protected

³⁾ May not exceed or fall short of operation in short-circuit protected network max. 8 A

⁴⁾ Signal transit time with resistive load

⁵⁾ With light/dark ratio 1:1

⁶⁾ Do not bend below 0 °C

Scanning range and operating reserve

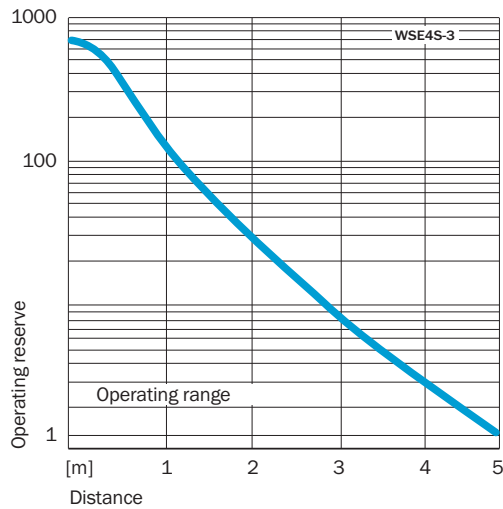
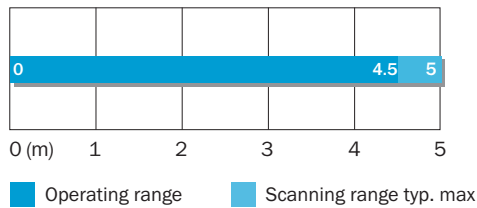

Ordering information

Type	Order no.
WSE4S-3E1330	1042093
WSE4S-3E2130	1042092
WSE4S-3F1330	1042090
WSE4S-3F2130	1042088
WSE4S-3F3130	1042089
WSE4S-3N1330	1042094
WSE4S-3P2130	1042091

Scanning range
0 ... 6 m

Through-beam photoelectric

- Fast and safe alignment through high visibility light spot
- Fast commissioning. Connect, align, ready!
- Easy assembly in slots and guide rails

Dimensional drawing

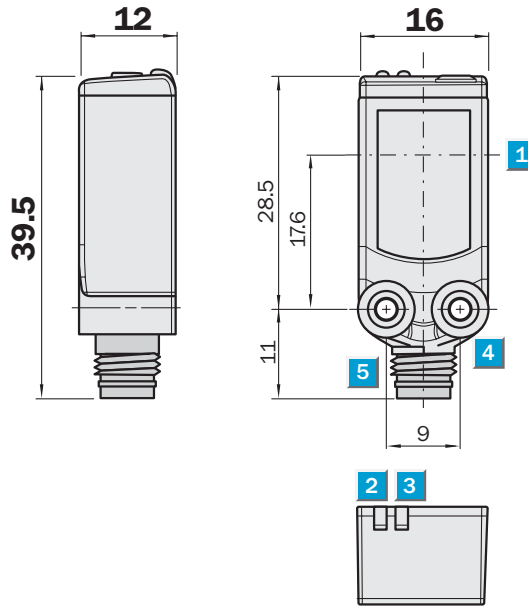

Adjustments possible

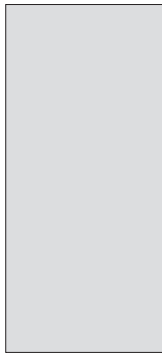

- 1 Centre of optical axis
- 2 LED signal strength indicator orange: status of received light beam
- 3 LED signal strength indicator green: power on
- 4 Mounting hole M3
- 5 Connector

Connection type

WSE4-3F3130	WSE4-3F2130	WSE4-3P2230	WSE4-3E1330
WSE4-3P3130	WSE4-3F2131		WSE4-3F1330
WSE4-3P3131	WSE4-3P2130		WSE4-3N1330

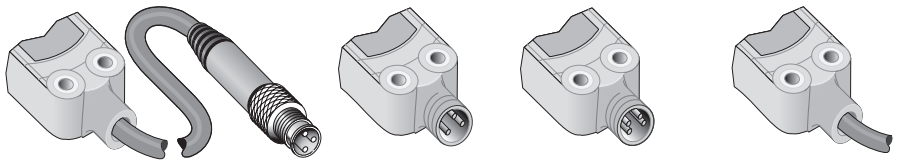

Sender M8, 3-pin M8, 3-pin M8, 4-pin 3 x 0.14 mm²

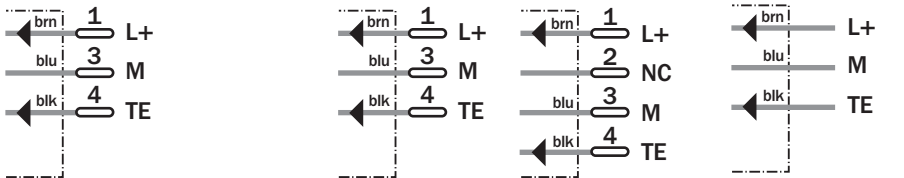

See Accessories chapter

- Connector, M8, 3-pin
- Connector, M8, 4-pin
- Mounting systems

Receiver M8, 3-pin M8, 3-pin M8, 4-pin 3 x 0.14 mm²

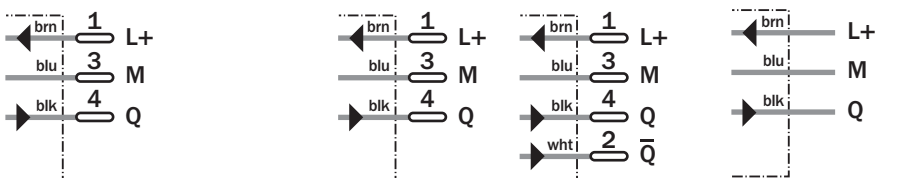

WSE4-3		E1330	F1330	F2130	F2131	F3130	N1330	P2130	P2230	P3130	P3131
Scanning range typ. max.	0 ... 6 m										
Scanning range, recommended	0 ... 5.5 m										
Sensitivity adjustment	Potentiometer, 5 revolutions										
Light source, light type	Pinpoint LED, red light, 650 nm ¹⁾										
Light spot diameter	210 mm at 2 m distance										
Supply voltage V_s	DC 10 ... 30 V ²⁾										
Ripple	≤ 5 V _{ss} ³⁾										
Power consumption, sender	≤ 20 mA										
Power consumption, receiver	≤ 20 mA										
Switching outputs	NPN, Q										
	PNP, Q										
	PNP										
Switching mode	Dark-switching										
	Light-switching										
	Complementary										
Output current I _a max	≤ 100 mA										
Response time	> 0.5 ms ⁴⁾										
Switching frequency	1,000 Hz ⁵⁾										
Test input sender off	TE to 0 V										
Connection type	Cable, 2 m ⁶⁾										
	Connector, M8, 3-pin										
	Cable with plug, M8, 3-pin, PVC, 100 mm ⁶⁾										
	Connector, M8, 3-pin ⁶⁾										
	Connector, M8, 4-pin										
Circuit protection	V _s connections reverse-polarity protected / Output Q and Q not short-circuit protected / Interference suppression										
Enclosure rating	IP 66, IP 67										
Ambient temperature operation	-40 °C ... +60 °C										
Ambient temperature storage	-40 °C ... +70 °C										
Weight	Ca. 40 g										
Housing material	Bayblend, PMMA										

¹⁾ Average service life 100,000 h at Ta = +25 °C

²⁾ Limit values, reverse-polarity protected

³⁾ operation in short-circuit protected network max. 8 A

⁴⁾ May not exceed or fall short of

⁵⁾ V_s tolerances

⁶⁾ Signal transit time with resistive load

⁷⁾ With light/dark ratio 1:1

⁸⁾ Do not bend below 0 °C

Scanning range and operating reserve

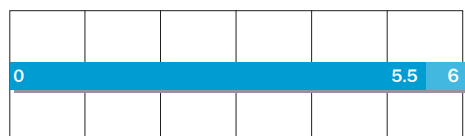

0 (m) 1 2 3 4 5 6
 ■ Operating range ■ Scanning range typ. max.

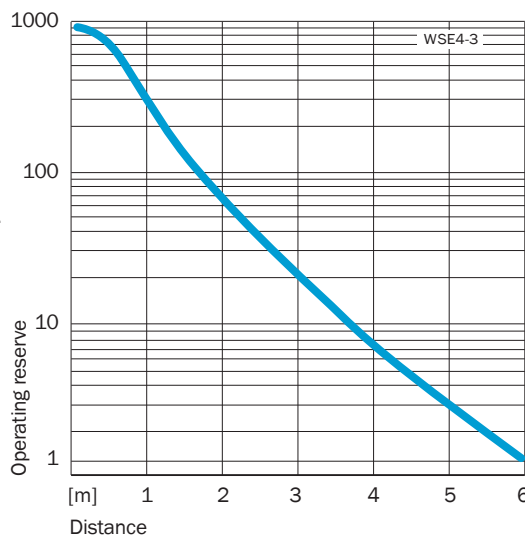

Ordering information

Type	Order no.
WSE4-3E1330	1028172
WSE4-3F1330	1028168
WSE4-3F2130	1028171
WSE4-3F2131	1041132
WSE4-3F3130	1028170
WSE4-3N1330	1028164
WSE4-3P2130	1028163
WSE4-3P2230	1028160
WSE4-3P3130	1028161
WSE4-3P3131	1029898

Scanning range
0 ... 3 m

Through-beam photoelectric

- Robust Teflon housing for use in wet and aggressive environments
- Suitable for food applications
- Test input

Dimensional drawing

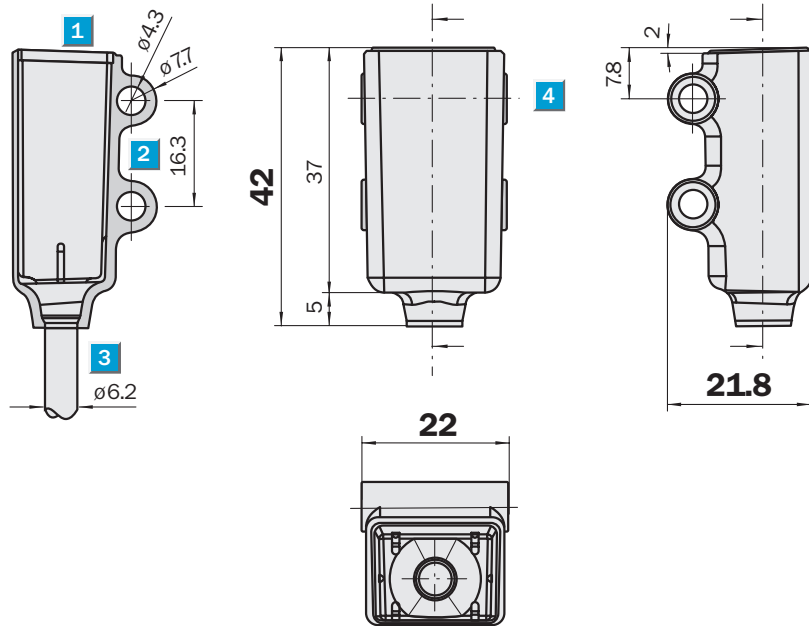

Adjustments possible

- 1 LED signal
- 2 Mounting hole \varnothing 4.3 mm
- 3 Cable 5 m, \varnothing 3.4 mm, 2 m Teflon coated, \varnothing 6.2 mm
- 4 Optical axis, sender und receiver

Connection type

WSE4T-3E1430
WSE4T-3F1430
WSE4T-3P1430

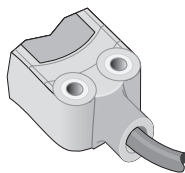

Sender 3 x 0.14 mm²

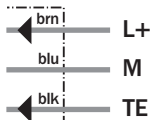

Receiver 3 x 0.14 mm²

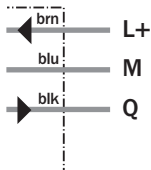

See Accessories chapter
Mounting systems

WSE4T-3		E1430	F1430	P1430							
Scanning range typ. max.	0 ... 3 m										
Scanning range, recommended	0 ... 2.5 m										
Light source, light type	Pinpoint LED, red light, 650 nm ¹⁾										
Light spot diameter	210 mm at 2 m distance										
Supply voltage V_s	DC 10 ... 30 V ²⁾										
Ripple	≤ 5 Vss ³⁾										
Power consumption, sender	≤ 20 mA										
Power consumption, receiver	≤ 20 mA										
Switching outputs	NPN, Q										
	PNP, Q										
Switching mode	Dark-switching										
	Light-switching										
Output current I _a max	≤ 100 mA										
Response time	> 0.5 ms ⁴⁾										
Switching frequency	1,000 Hz ⁵⁾										
Test input sender off	TE to 0 V										
Connection type	Cable, 5 m ⁶⁾										
Circuit protection	V _s connections reverse-polarity protected / Output Q and Q not short-circuit protected / Interference suppression										
Enclosure rating	IP 68, IP 69K										
Ambient temperature operation	-40 °C ... +60 °C										
Ambient temperature storage	-40 °C ... +70 °C										
Weight	Ca. 60 g										
Housing material	PTFE/teflon, PMMA										

¹⁾ Average service life 100,000 h at operation in short-circuit protected network max. 8 A V_s tolerances
²⁾ Limit values, reverse-polarity protected ³⁾ May not exceed or fall short of ⁴⁾ Signal transit time with resistive load
⁵⁾ With light/dark ratio 1:1 ⁶⁾ Do not bend below 0 °C

Scanning range and operating reserve

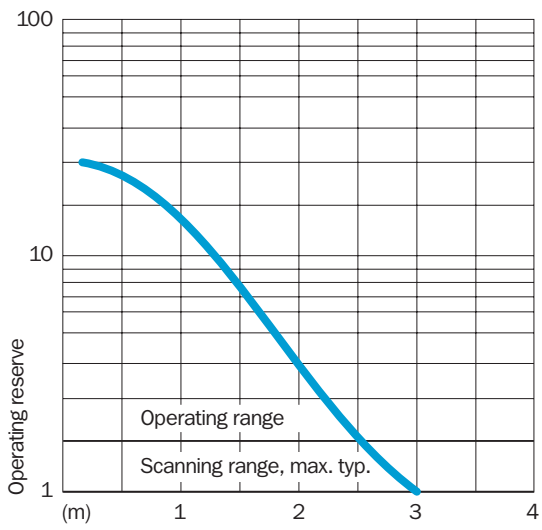
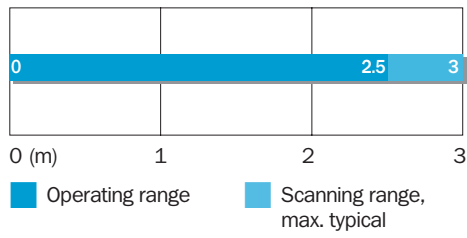

Ordering information	
Type	Order no.
WSE4T-3E1430	1029648
WSE4T-3F1430	1029647
WSE4T-3P1430	1029646

Dimensional drawings and order information

Connectors

SENSICK sheath M8, 3- or 4-pin, enclosure rating IP 67

Female connector M8, 3- or 4-pin, straight

Type	Order no.	Contacts
DOS-0804-G	6009974	4

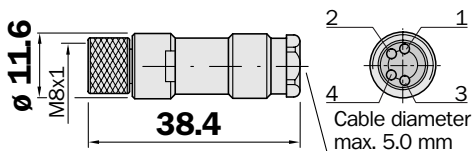

Female connector M8, 3- or 4-pin, angled

Type	Order no.	Contacts
DOS-0804-W	6009975	4

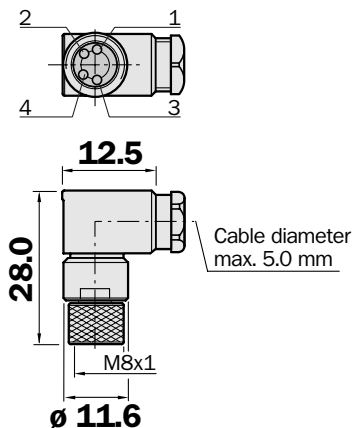

Female connector M8, 3- or 4-pin, straight

3 x 0.34 mm² or 4 x 0.25 mm², sheath PVC

Type	Order no.	Contacts	Cable length
DOL-0803-G02M	6010785	3	2 m
DOL-0803-G05M	6022009	3	5 m
DOL-0803-G10M	6022011	3	10 m
DOL-0804-G02M	6009870	4	2 m
DOL-0804-G05M	6009872	4	5 m
DOL-0804-G10M	6010754	4	10 m

Female connector M8, 3- or 4-pin, angled

3 x 0.34 mm² or 4 x 0.25 mm², sheath PVC

Type	Order no.	Contacts	Cable length
DOL-0803-W02M	6008489	3	2 m
DOL-0803-W05M	6022010	3	5 m
DOL-0803-W10M	6022012	3	10 m
DOL-0804-W02M	6009871	4	2 m
DOL-0804-W05M	6009873	4	5 m
DOL-0804-W10M	6010755	4	10 m

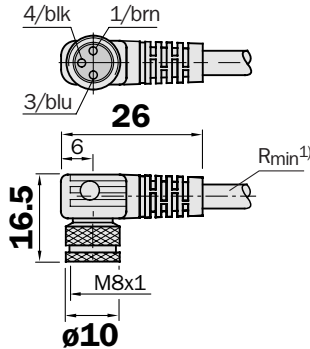
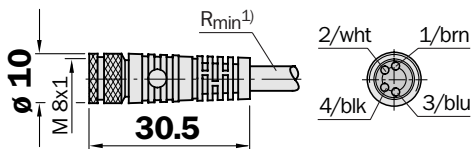

¹⁾ Minimum bend radius in dynamic use
R_{min} = 20 x cable diameter

Female connector M8, 3-pin, straight

Cable diameter 4.5 mm, 3 x 0.25 mm², sheath PUR, halogen free

Type	Order no.	Cable length
DOL-0803-G05MB	7902080	5 m

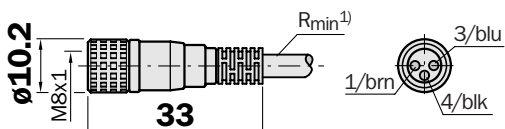

Female connector M8, 3-pin, angled

Cable diameter 4.5 mm, 3 x 0.25 mm², sheath PUR, halogen free

Type	Order no.	Cable length
DOL-0803-W05MB	7902081	5 m

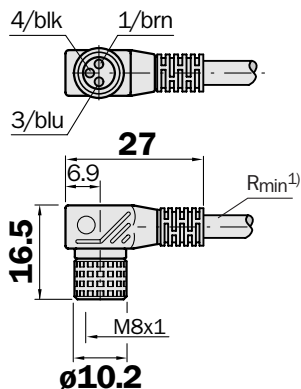

Dimensional drawings and order information

Reflectors

Plastic design for temperatures up to 65 °C

Micro triple reflector 20 x 20 mm

Type	Order no.
PL10F	5311210

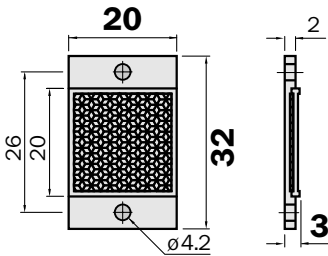

Reflector 20 x 40 mm

Type	Order no.
PL20A	1012719

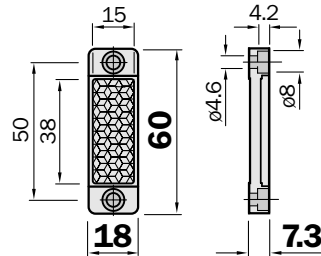

Reflector Ø 22 mm, plug-in

Type	Order no.
PL22-1	1003546

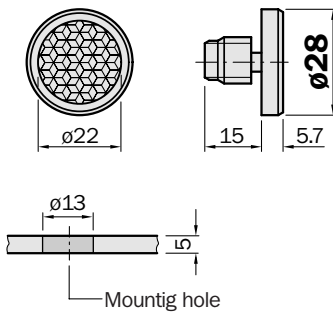

Reflector Ø 22 mm, self-adhesive

Type	Order no.
PL22-2	1003621

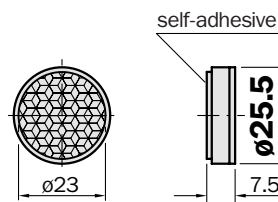

Reflector 30 x 50 mm

Type	Order no.
PL30A	1002314

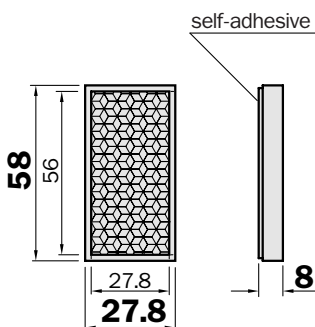

Reflector 40 x 60 mm

Type	Order no.
PL40A	1012720

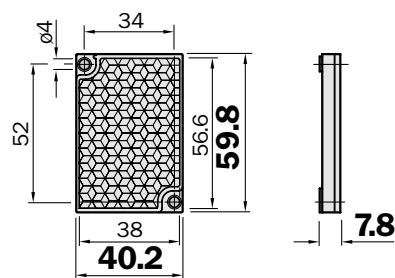

Australia

Phone +61 3 9497 4100
1800 33 48 02 – tollfree
E-Mail sales@sick.com.au

Belgium/Luxembourg

Phone +32 (0)2 466 55 66
E-Mail info@sick.be

Brasil

Phone +55 11 3215-4900
E-Mail sac@sick.com.br

Ceská Republika

Phone +420 2 57 91 18 50
E-Mail sick@sick.cz

China

Phone +852-2763 6966
E-Mail ghk@sick.com.hk

Danmark

Phone +45 45 82 64 00
E-Mail sick@sick.dk

Deutschland

Phone +49 211 5301-250
E-Mail info@sick.de

España

Phone +34 93 480 31 00
E-Mail info@sick.es

France

Phone +33 1 64 62 35 00
E-Mail info@sick.fr

Great Britain

Phone +44 (0)1727 831121
E-Mail info@sick.co.uk

India

Phone +91-22-4033 8333
E-Mail info@sick-india.com

Israel

Phone +972-4-999-0590
E-Mail info@sick-sensors.com

Italia

Phone +39 02 27 43 41
E-Mail info@sick.it

Japan

Phone +81 (0)3 3358 1341
E-Mail support@sick.jp

Nederlands

Phone +31 (0)30 229 25 44
E-Mail info@sick.nl

Norge

Phone +47 67 81 50 00
E-Mail austefjord@sick.no

Österreich

Phone +43 (0)22 36 62 28 8-0
E-Mail office@sick.at

Polska

Phone +48 22 837 40 50
E-Mail info@sick.pl

Republic of Korea

Phone +82-2 786 6321/4
E-Mail kang@sickkorea.net

Republika Slovenija

Phone +386 (0)1-47 69 990
E-Mail office@sick.si

România

Phone +40 356 171 120
E-Mail office@sick.ro

Russia

Phone +7 495 775 05 34
E-Mail info@sick-automation.ru

Schweiz

Phone +41 41 619 29 39
E-Mail contact@sick.ch

Singapore

Phone +65 6744 3732
E-Mail admin@sicksgp.com.sg

Suomi

Phone +358-9-25 15 800
E-Mail sick@sick.fi

Sverige

Phone +46 10 110 10 00
E-Mail info@sick.se

Taiwan

Phone +886 2 2365-6292
E-Mail sickgrc@ms6.hinet.net

Türkiye

Phone +90 216 587 74 00
E-Mail info@sick.com.tr

USA/Canada/México

Phone +1(952) 941-6780
1 800-325-7425 – tollfree
E-Mail info@sickusa.com

More representatives and agencies
in all major industrial nations at
www.sick.com